

Multisensory Equipment



experia
multisensory for everyone



Hello...

Bonjour, Ciao, Hola, Olá, Salaam, Guten Tag, Namaste, Merhaba, Ni Hau, Halo, Nay Hoh, Hallo, Hej, Geia Sas, Sveiki, Hei, Czesc, Marhabaan, Kon'nichiwa

Welcome to our 2022 brochure packed full of innovative and inspirational products.

Now in our 16th year, we continue to develop new products based on what you, our clients tell us you need. We produce the very latest products offering innovative and exciting features for everyone, regardless of ability or age.

We are proud to present the pioneering Immersive Reality space. A brand-new type of

sensory space that adds an extra dimension to your therapy suite. It is a fantastic addition to the standard sensory room and taking the UK by storm. Please contact us to see one in action, see pages 62-65 for more information.

So, whether sensory environments are new, or you are an experienced user wanting to upgrade, we are here to help you make the right decision.

Let's begin...

This contents page will help you navigate through the brochure towards the sensory equipment that is perfect for you and your users.

If you are not sure where to start, we recommend looking at our bundles on pages 86-89, or our room packages on pages 90-101. Why not give us a call? ...We are here to help you every step of the way.

Welcome

- Why Choose Experia 4
- One Great Big Family 5
- 3D Design..... 6-7
- Case Study 8-9

Multisensory Equipment

- Bubble Tubes 10-18
- Bubble Walls 20-23
- Fibre Optics 24-31
- Projection 32-36
- IRIS 38-59
- Case Study 60-61
- Immersive Reality Spaces 62-65
- Interactive Floor 66-67
- Wall Panels 68-71
- Wall Panels - Sound
- Activated 72-75
- Tactile 76-77
- Sensory Effects..... 78-79
- Sensory Lighting 80-83
- Sensory Ceiling 84-85
- Sensory Bundles..... 86-89
- Sensory Room Packages 90-101
- Portable 102-109
- De-Escalation 110-117
- Rebound 118-121
- Sensory Bathrooms 122-123
- Sensory Pools 124-129
- MiLE 130-133
- UV Blacklight..... 134-139
- Sound & Music 140-143
- Aromatherapy 144-147
- Sensory Integration 150-157
- Soft Play 158-170
- Waterbeds 171
- Soft Furniture 172-175
- Vibro-acoustic..... 176-177

Helpful Info

- Choose your Colour 178-179
- Order Form 180
- VAT Exemption Form 181
- 3D Design Request..... 182-183
- Index..... 184-187



Why Choose Experia

To make the process of choosing and installing your sensory equipment as enjoyable, inspiring and as easy as possible, we offer the services of a dedicated sensory advisor. They will be your key contact when discussing your needs with us.

Whether you have a clear idea of what you want your sensory equipment to do or you are in need of some inspiration, we can help.

Our sensory advisors have extensive knowledge of all our products and will listen to your requirements. Together, you will determine what you and your users need from the equipment, how best to meet those needs, and ultimately, which products to purchase.

They will guide you through every step of the process, making choosing equipment or designing a full room easy and straightforward.



One Great Big Family

For over 16 years, Experia has been manufacturing and supplying multi-sensory equipment to clients worldwide and our clients keep coming back!

Together we have become one big family

We pride ourselves in working closely with all our clients, new or existing. It is this collaborative approach that means we deliver outstanding sensory environments across the UK and worldwide and focus on changing people's lives for the better.



Working together to create life changing equipment

After 16 years, collaboration and innovation is still our focus at Experia. You have told us about the needs of your users and how best our products can support you working with all ages and abilities. We have used this information to develop fantastic products. It is this combination of experience and innovation, that ensures we both continue to change your users lives.

Constant development

We are passionate about inclusion and believe everyone should be able to access our products, regardless of age or ability. We listen to our clients' ideas and design innovative products to meet these specific needs. That is why we promise that if we don't already do a product to suit your users' abilities, you can simply let us know and we will design something especially for you!

The very best people

We employ the very best staff in the industry with a wide range of skills. Our skilled, diligent and experienced technicians build superb products to exacting standards, meaning your environment is created with the attention to detail it deserves.



Finest manufacturing

We use the very finest lean manufacturing techniques to ensure you get the very best products at the

best possible price. We use world class processes and procedures to ensure we build the perfect product every time, so you know you are always getting the best. We were the first in the UK to offer a 3-year warranty and continue that guarantee, as we now offer up to 5 years for your peace of mind.



Ongoing support

We believe that maintaining your sensory environment involves both keeping the equipment running smoothly and ensuring that staff are confident in using the products. That is why our aftercare packages offer both a Maintenance and Training Contract, to ensure both your environment and your people continue to perform to their maximum potential.



3D Designs

Visualise what your finished space will look like with your own 3D CAD drawing.

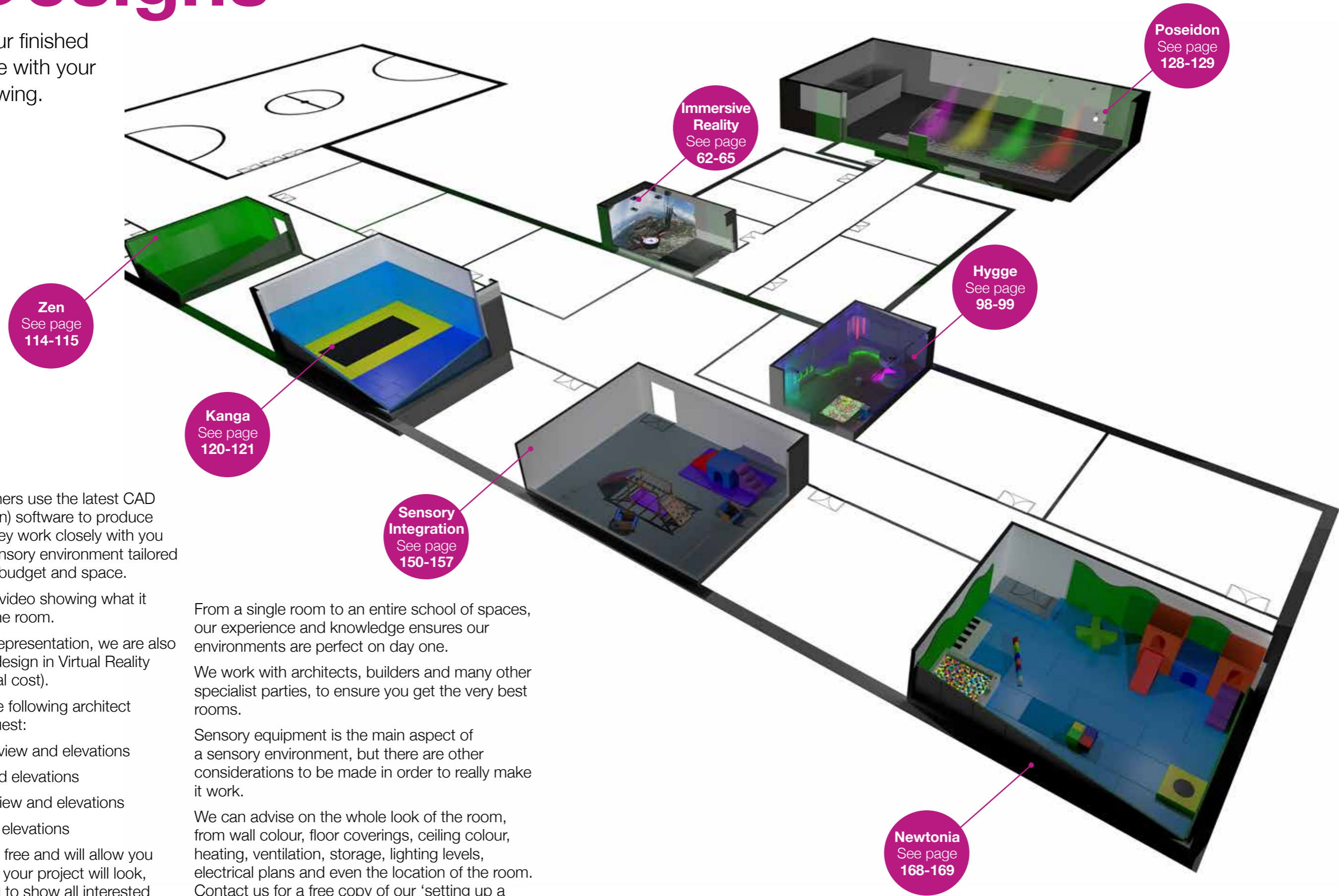

Our experienced designers use the latest CAD (Computer Aided Design) software to produce stunning 3D visuals. They work closely with you to create the perfect sensory environment tailored to your specific needs, budget and space.

We can also offer a 3D video showing what it would be like to be in the room.

For the ultimate visual representation, we are also delighted to offer your design in Virtual Reality (VR) format (at additional cost).

We can also provide the following architect approved plans on request:

- Product location overview and elevations
- Electrical overview and elevations
- Specialist cable overview and elevations
- Patress overview and elevations

All of these services are free and will allow you to quickly visualise how your project will look, so that it is easy for you to show all interested parties what they can expect.

From a single room to an entire school of spaces, our experience and knowledge ensures our environments are perfect on day one.

We work with architects, builders and many other specialist parties, to ensure you get the very best rooms.

Sensory equipment is the main aspect of a sensory environment, but there are other considerations to be made in order to really make it work.

We can advise on the whole look of the room, from wall colour, floor coverings, ceiling colour, heating, ventilation, storage, lighting levels, electrical plans and even the location of the room. Contact us for a free copy of our 'setting up a sensory environment guide.'

Case Study

Polden Bower

Polden Bower is a special school in Bridgwater, Somerset, which caters for 160 students with complex needs, including those with significant mobility difficulties.

The students range in ages from 4 to 16. The creation of the school has provided additional much-needed school places for students with special educational needs across the region.

Pupils, parents and teachers influenced Polden Bower's design, which includes a warm water pool for physiotherapy, a sports hall, dining hall, sensory and therapy rooms, as well as fully-accessible classrooms equipped with the latest teaching technology.

The rooms installed by Experia include an Immersive Space, a rebound therapy room, five safe spaces (two of them being sensory safe spaces), a soft play environment, a sensory room, and a warm water sensory pool - so many amazing spaces for pupils to relax, learn, and enjoy!

As well as all of these amazing facilities, the school's external area also includes a sensory garden, multi-use games area and adventure playground - providing lots of spaces to support the pupils' physical and sensory needs.



There is also a café to help students develop life skills and to encourage engagement and interaction with the wider community. This is particularly beneficial for the older students, who can learn about the world of work.

Somerset County Council wanted to create the school as part of the local authority's initiative to increase SEN school provisions throughout the district. This ensures that more children with special educational

needs can have their requirements met close to home, as well as in high quality modern facilities.

Construction of the school started in 2018, and was completed during the pandemic, as well as on a challenging site that had to battle flooding after multiple winter storms! The construction team involved overcame many obstacles to deliver the school successfully to Somerset County Council.

The team at Polden Bower pride themselves on their educational philosophy - knowing that whatever they do, it is always children first. At Polden Bower they aspire to be the best, and more importantly achieve the best outcomes for their pupils. Their mantra is 'Believe you can' - as they embrace the view that all people are unique and require access to an education that reflects their differences.

A modern and innovative school, Polden Bower wanted to provide a range of inclusive sensory spaces to provide multi-functionality to all students. Because of this, Experia's expertise was needed to bring a diverse range of sensory solutions to the school.



"Excellent - First Class!"

Helen Farnell - Executive Headteacher at Polden Bower School

All rooms were designed with the primary function in mind, and Experia worked closely with architects, the school, and other key stakeholders to create a suite of stunning sensory environments. The school is delighted to have some of the finest sensory spaces in the UK. From an exciting soft play space designed to let off steam and develop key gross motor skills, to the sensory safe spaces where children can go to relax and de-stress. From the pool where pupils can learn to swim and enjoy physiotherapy, to the awe-inspiring immersive space designed for teaching, stimulation, learning and enjoying new experiences and simulations.

Spotlight on... the Immersive Reality Space

Whilst we installed many fantastic sensory spaces, of note is the unique Immersive Reality space. We specifically designed and constructed the room to fit an immersive space, hence the very large size of the room - two thirds of the room is the immersive space, and the other third of the room is an incorporated sensory room.

Gareth from our team said, "We were very lucky as the room was purpose built, but this meant working closely with architects, the construction company, electricians, carpet fitters and other trades to ensure the school got the perfect room."

Because the room was built with an immersive space in mind, the creation process was made much easier. However, we have also worked with establishments

in the past who have had existing rooms specifically adapted to accommodate an immersive space. This shows how diverse our rooms are - they can either be worked into the design of a new school, or incorporated into a room in an existing school.

Accessible for all, the space is versatile and can be used for many different purposes. Executive Headteacher Helen explained that the uses of the space range from "teaching and learning, employability skills, relaxation, therapeutic intervention, nurture intervention", among many others. She also said "it has been used for a memory activity following a child death we experienced in the school."

Helen explained that the school has seen a huge "impact on communication and language, as well as improved engagement in pupils' learning" since the installation of their Immersive Space. The benefits of the room are endless!

The students at Polden Bower love interacting with the extensive range of content available in the immersive space. The most popular scenes according to Helen are the underwater scenes, woodland scenes and the calming candles scene.

Describing our service and training as "Excellent - First Class!", Helen gave her advice to anyone who may be interested in getting an immersive space installed. She said "talk openly to the team about the use of the space and the experiences you want to create. They actively listen, and certainly worked with us to create the best. Talk to Gareth and the team - they are excellent!"

If your pupils deserve a room like this, contact us on 0800 612 6077 or email us at info@experia.co.uk.



LED Bubble Tubes



Made in the UK, our Bubble Tubes utilise the very best in LED technology, meaning they're super low maintenance, completely silent and brighter than you can imagine.

Featuring a stylish curved base and clear domed lids, they create a beautiful rippling effect on the ceiling, just like water.

Our Bubble Tubes have a range of benefits for a host of users with differing abilities, including visual tracking, auditory awareness, social interaction relaxation and many more.

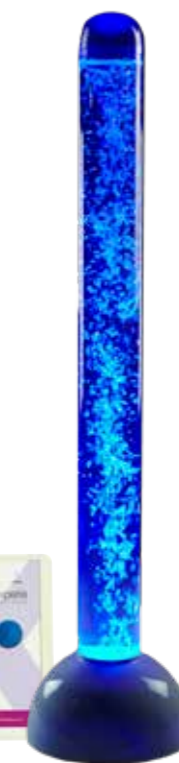

Skills	Calming Bubble Tube	Inter-active Bubble Tube	Super-active Bubble Tube	IRIS Bubble Tube	IRiS + Bubble Tube	Touch sensitive Bubble Tube	Mini LED Bubble Tube	Portable LED Bubble Tube
Relaxation	✓	✓	✓	✓	✓	✓	✓	✓
Tactile	✓	✓	✓	✓	✓	✓	✓	✓
Cause and Effect		✓	✓	✓	✓	✓		
Colour Recognition		✓	✓	✓	✓	✓		
Switching Skills		✓	✓	✓	✓	✓		
Dexterity		✓	✓	✓	✓	✓		
Distraction Therapy	✓	✓	✓	✓	✓	✓	✓	✓
Vocalisation				✓	✓			
Gross Motor Skills				✓	✓			
Fine Motor Skills				✓	✓			
Hand to Eye Coordination				✓	✓			
Social Skills				✓	✓			
Balance Skills				✓	✓			
Group Participation				✓	✓			
Tracking Skills	✓	✓	✓	✓	✓	✓	✓	✓

- Bubble Tubes come in three heights; 1m, 1.5m and 2m unless otherwise stated.
- All our Bubble Tubes are powered using mains voltage which is transformed to a safe low voltage unless otherwise stated.
- To ensure optimum stability on tubes over 1.5m, we recommend the Bubble Tube Bracket is utilised.
- All wireless controllers feature Qi charging, so there's no battery to change.
- We offer a 3-year warranty on all Bubble Tubes, giving you peace of mind.

Calming LED Bubble Tube

Relax the senses with the Calming LED Bubble Tube. Enjoy the view as the Bubble Tube gently moves through a range of vibrant colours to create a sense of calm and tranquillity in any sensory room. Hundreds of brightly coloured bubbles gently float through the 150mm wide bubble tube, creating a truly relaxing experience for the user. The Calming LED Bubble Tube is a wonderful addition to any sensory space.

- Calming LED Bubble Tubes**
- 1m Tube** 122 02 00 01 1 £659.00
 - 1.5m Tube** 122 02 00 01 2 £681.00
 - 2m Tube** 122 02 00 01 3 £714.00

Bubble Tube Bracket for 150mm Tubes 122 02 00 03 1 £44.99

Interactive LED Bubble Tube

Ideal for developing cause and effect and colour recognition skills. The Interactive LED Bubble Tube is an entry level tube, which not only creates a calming aura for the user to enjoy, but also works great to aid development of lifeskills. Users can remotely control 4 colours shown in the bubble tube with the Wireless Colour Selector (provided). Alternatively, allow the bubble tube to gently move through the colour changes slowly to soothe the user. Users can also start and stop the bubbles with the Wireless Colour Selector and choose which colour to display.

Dimensions: Tube is 150mm in diameter.

- Interactive LED Bubble Tubes**
- 1m Tube** 122 50 00 15 1 £799.00
 - 1.5m Tube** 122 50 00 15 2 £825.00
 - 2m Tube** 122 50 00 15 3 £849.00

Bubble Tube Bracket for 150mm Tubes 122 02 00 03 1 £44.99

Superactive LED Bubble Tube

Develop key life skills in a fun way with the Superactive LED Bubble Tube. Using the Wireless Colour Selector (provided), users can remotely control a range of 8 colours shown within the Bubble Tube, or allow it to move through the colours automatically on a slow setting. Users can also opt to start and stop the bubbles with the Wireless Colour Selector and choose which colour to display. The Superactive LED Bubble Tube works well to aid in development of cause and effect skills, along with colour recognition. It also helps calm users with the soothing colour display used in calming mode.

Dimensions: Tube is 150mm in diameter.

- Superactive LED Bubble Tubes**
- 1m Tube** 122 56 00 15 1 £912.00
 - 1.5m Tube** 122 56 00 15 2 £949.00
 - 2m Tube** 122 56 00 15 3 £999.00

Bubble Tube Bracket for 150mm Tubes 122 02 00 03 1 £44.99

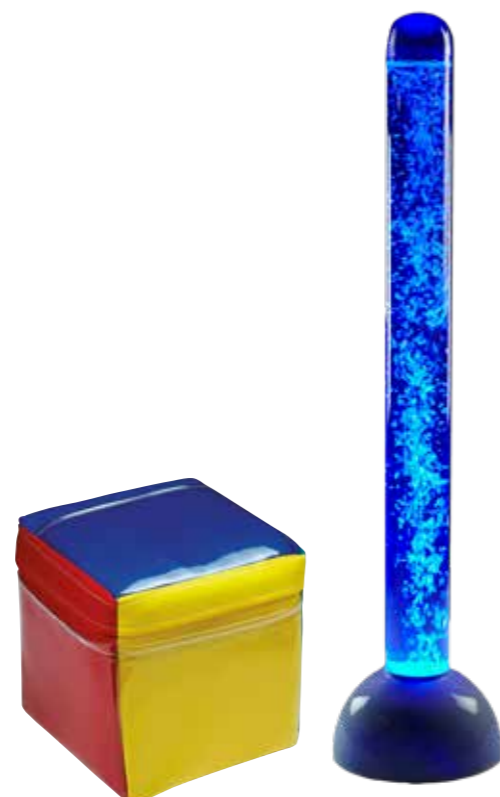

IRiS LED Bubble Tube



If you want the best of the best, this is it! The IRiS LED Bubble Tube is a key part of the state-of-the-art wireless IRiS range; this means it works in conjunction with a large range of additional IRiS products.

Users can develop key life skills with the range of wireless switches available with this product. The Bubble Tube can also be controlled by any IRiS talker (switch), available separately, see page 41.

An essential addition for any sensory room, bedroom or learning environment.

The IRiS LED Bubble Tube features a beautiful display of calming water, invigorating bubbles and a range of 8 coloured lights encased within a durable and large 150mm wide tube.

This Bubble Tube also aids in development of cause and effect skills, along with colour recognition. It also helps calm users with the soothing colour display used in calming mode.

Dimensions: This Bubble Tube is 150mm in diameter.

IRiS LED Bubble Tubes

1m Tube 122 01 00 13 1	£1,209.00
1.5m Tube 122 01 00 13 2	£1,264.00
2m Tube 122 01 00 13 3	£1,319.00

Bubble Tube Bracket for 150mm Tubes

122 02 00 03 1	£44.99
----------------	--------

IRiS LED Bubble Tube, Recordable Speaker & Qube Bundle

Introduce the state-of-the-art wireless IRiS range for the best interactive learning with this brilliant bundle.

This bundle comes complete with large 1.5m IRiS Bubble Tube, IRiS Recordable Speaker and IRiS 200m Qube, which operates from a distance of 30m – fantastic in larger rooms. To develop colour recognition and cause and effect skills, users can roll the Qube and whichever colour is displayed on the top, is then shown within the 150mm wide Bubble Tube. The colour is then announced by the Recordable Speaker. The Speaker includes 64 pre-recorded sounds, musical clips and noises, with the option to specifically tailor another 16 sounds, making it unique to your requirements.

Please Note: The Recordable Speaker and Bubble Tube are mains powered, which is transformed to a safer low voltage, while the Qube uses a 9V PP3 Battery which is supplied. This Bubble Tube is 150mm in diameter.

IRiS LED Bubble Tube and Qube Bundle

122 01 00 81	£1,649.00
--------------	-----------

Bubble Tube Bracket for 150mm Tubes

122 02 00 03 1	£44.99
----------------	--------

IRiS+ LED Bubble Tube

The wireless control capabilities with this Bubble Tube mean you can control it wirelessly with almost any mobile device. The IRiS+ LED Bubble Tube comes with an easy-to-use free downloadable app which features a comprehensive range of interactive options for users to experience.

Features include a range of 8 colour options and 10 handy switch modes including touch, sound, vibration, rotation and relaxation, meaning the possibilities are endless for exciting and entertaining users across all abilities. The app is available from any App Store and is called Experia IRiS+.

This Bubble Tube also aids in development of cause and effect skills, along with colour recognition. It also helps calm users with the soothing colour display to create a relaxed sensory space.

Dimensions: This Bubble Tube is 150mm in diameter.

IRiS+ LED Bubble Tube

1m Tube 122 16 00 02 1	£1,630.00
1.5m Tube 122 16 00 02 2	£1,650.00
2m Tube 122 16 00 02 3	£1,670.00

Bubble Tube Bracket for 150mm Tubes

122 02 00 03 1	£44.99
----------------	--------

Gigantic LED Bubble Tubes

Need a Bubble Tube that's bigger? No problem. Our standard tube diameter is 150mm but these 200mm tubes help create more of a feature in a sensory room, especially when used alongside one or two standard sized bubble tubes.

Calming LED Bubble Tubes

1m x 200mm Dia 122 02 00 11 1	£769.00
1.5m x 200mm Dia 122 02 00 11 2	£791.00
2m x 200mm Dia 122 02 00 11 3	£824.00

Interactive LED Bubble Tubes

1m x 200mm Dia 122 50 00 20 1	£934.00
1.5m x 200mm Dia 122 50 00 20 2	£956.00
2m x 200mm Dia 122 50 00 20 3	£978.00

Superactive LED Bubble Tubes

1m x 200mm Dia 122 56 00 20 1	£934.00
1.5m x 200mm Dia 122 56 00 20 2	£956.00
2m x 200mm Dia 122 56 00 20 3	£978.00

IRiS Gigantic LED Bubble Tubes

1m x 200mm Dia 122 01 00 13 5	£1,539.00
1.5m x 200mm Dia 122 01 00 13 6	£1,484.00
2m x 200mm Dia 122 01 00 13 7	£1,429.00

Bubble Tube Bracket for 200mm Dia

122 02 00 03 2	£54.99
----------------	--------



Touch Sensitive LED Bubble Tube

Great for interaction and ideal for those with limited mobility, users can touch the coloured buttons shown at the base of this Bubble Tube to control the colour. The Touch Sensitive LED Bubble Tube uses the very latest technology to sense hand movement and the user is rewarded with a colour change of one of their four chosen colours. Aside from the cutting-edge technology, this product uses, it also features a calming mode that gently moves through colours to soothe and relax the user. This Bubble Tube also aids in development of cause and effect skills, along with colour recognition.

Dimensions: This Bubble Tube is 150mm in diameter.

Touch Sensitive LED Bubbles

1m Tube 122 02 00 09 1 £989.00
1.5m Tube 122 02 00 09 2 £1,044.00
2m Tube 122 02 00 09 3 £1,099.00

Bubble Tube Bracket for 150mm Tubes

122 02 00 03 1 £44.99

Portable LED Bubble Tube

Super lightweight at only 3.6kg, the Portable LED Bubble Tube is easy to move around to be placed where it's needed. This Bubble Tube comes in calming mode as standard and gently moves through the 8 bright colours which illuminate throughout the 120mm wide bubble tube. Due to its portability, the Bubble Tube is small enough to fill up in a bathroom or kitchen tap; it doesn't need a hose and is easy to empty. Despite being so lightweight, it's made from a strong robust tin tube that won't bend or break.

Dimensions: This Bubble Tube is 1m high with a 120mm diameter base.

Portable LED Bubble Tube

122 02 00 07 £439.00

Mini LED Bubble Tube

It may be small, but it really packs a punch when it comes to elevating your sensory environment. The Mini LED Bubble Tube is the ideal solution when space is minimal. The smallest bubble tube in our range, this one is jam packed with super bright LED technology. The Mini LED Bubble Tube takes the user on a calming sensory journey as it gently scrolls through eight vibrant colour variations that illuminate up the 100mm wide Bubble Tube. A benefit is that it's super lightweight at only 1.9kg, which allows it to be lifted easily into place.

Dimensions: The Mini LED Bubble Tube is 500mm high with a 75mm diameter base.

Mini LED Bubble Tube

122 02 00 33 £399.00

Interactive LED Bubble Tube Corner

The Interactive LED Bubble Tube Corner encourages users to get right up close to interact with the tube in comfort. Four touch sensitive buttons are integrated into the plinth which lets the user scroll at leisure between four vibrant colours. This product also features a calming mode that gently moves through colours in the 1.5m high tube. This soothes and relaxes the user, creating a chilled-out environment.

The Interactive LED Bubble Tube Corner also comes complete with two shatterproof acrylic mirrors which reflect the Bubble Tube to further enhance its effects.

Please Note: The plinth is available in any standard Experia vinyl colour. Comes complete with a Bubble Tube Wall Bracket for added stability.

Dimensions: Plinth - 900mm L x 900mm W x 400mm H.
 Bubble Tube - 1.5m height x 150mm Dia tube.

Interactive LED Bubble Tube Corner

122 48 00 93 £2,099.00

LED Bubble Tube & Softie

Get closer in comfort and feel the vibrations with the LED Bubble Tube and Softie. Encased in a large bean filled Softie, this 150mm Bubble Tube encourages users to get up close to interact. This Bubble Tube also comes in calming mode as it takes the user on a calming sensory journey and gently scrolls through eight vibrant colour variations.

Please Note: The Softie is available in any standard Experia vinyl colour.

Dimensions: Bubble Tube - 1m height x 150mm Dia tube.
 Softie 500mm H x 1350mm W Dia.

LED Bubble Tube Softie

122 32 00 17 1 £1,169.00

Softie Only

122 32 00 17 2 £267.75

Bubble Tubes

Accessories



Square Bubble Tube Plinth

Users can get up and sit close to the Square Bubble Tube Plinth and feel the vibrations of the flowing water in their bubble tube. The plinth is covered in a soft, easy to clean and durable vinyl, and is available in any standard Experia vinyl colour. This allows you to perfectly match your product with your décor, see page 178-179 for details.

Plinth Sizes: Plinth is available in three sizes and will fit any standard 150mm diameter and 200mm diameter bubble tubes. For bespoke sizes, please contact us.

Dimensions:

Small: 700mm L x 700mm W x 400mm H
 Medium: 900mm L x 900mm W x 400mm H
 Large: 1200mm L x 1200mm W x 400mm H

Small - Standard Tube	122 32 00 21 1	£230.00
Medium - Standard Tube	122 32 00 21 2	£295.00
Large - Standard Tube	122 32 00 21 3	£416.00
Small - 200mm Dia	122 32 00 21 4	£230.00
Medium - 200mm Dia	122 32 00 21 5	£295.00
Large - 200mm Dia	122 32 00 21 6	£416.00

Curved Bubble Tube Plinth

A more modern, stylish variation of the square plinth, users can get up and sit close to feel the vibrations of the flowing water in their bubble tube. The plinth is covered in a soft, easy to clean and durable vinyl, and is available in any standard Experia vinyl colour. This allows you to perfectly match your product with your décor, see page 178-179 for details.

Plinth Sizes: Plinth is available in two sizes and will fit any standard 150mm diameter and 200mm diameter bubble tubes. For bespoke sizes, please contact us.

Dimensions:

Medium: 900mm L x 900mm W x 400mm H
 Large: 1200mm L x 1200mm W x 400mm H

Medium - Standard Tube	122 32 00 30 1	£345.00
Large - Standard Tube	122 32 00 30 2	£430.00
Medium - 200 Dia	122 32 00 30 3	£345.00
Large - 200 Dia	122 32 00 30 4	£430.00



Safe Mirror

A safer alternative to glass, our shatterproof acrylic mirrors are perfect for creating the reflective illusion of multiple bubble tubes, ideal for mounting to any Experia plinth. Each mirror is 3mm thick and made from shatterproof acrylic. These mirrors help enhance the sensory experience for the user when used alongside a Bubble Tube and plinth combination. The Safe Mirror comes in three sizes to accommodate any Experia plinth.

Dimensions:

Small: 900mm W x 1200mm H
 Medium: 900mm W x 1500mm H
 Large: 1200mm W x 1200mm H

Small	122 67 00 04	£82.50
Medium	122 67 00 05	£130.90
Large	122 67 00 06	£103.40

Safe Mirror - Timber Backed (Single)

This is a version of our Safe Acrylic Mirrors which are reinforced with a strong timber back to ensure strength and durability. Each mirror is 12mm thick and made from shatterproof acrylic. These mirrors help enhance the sensory experience for the user when used alongside a Bubble Tube and plinth combination. The Timber backed mirror comes in five sizes to accommodate any Experia plinth.

Dimensions:

V. Small: 900mm W x 900mm H
 Small: 900mm W x 1200mm H
 Medium: 900mm W x 1500mm H
 Large: 1200mm W x 1200mm H
 V. Large: 1200mm W x 1500mm H

V. Small	122 67 00 14	£157.00
Small	122 67 00 15	£157.00
Medium	122 67 00 16	£229.00
Large	122 67 00 17	£205.00
V. Large	122 67 00 18	£229.00

Safe Mirror - Timber Backed (Pair)

This is a version of our Safe Acrylic Mirrors in a pair, which are reinforced with a strong timber back to ensure strength and durability. Each mirror is 12mm thick and made from shatterproof acrylic. These mirrors help enhance the sensory experience for the user when used alongside a Bubble Tube and plinth combination. The Timber backed mirror comes in five sizes to accommodate any Experia plinth.

Dimensions:

V. Small: 900mm W x 900mm H
 Small: 900mm W x 1200mm H
 Medium: 900mm W x 1500mm H
 Large: 1200mm W x 1200mm H
 V. Large: 1200mm W x 1500mm H

V. Small (pair)	122 67 00 32	£313.00
Small (pair)	122 67 00 33	£313.00
Medium (pair)	122 67 00 34	£458.00
Large (pair)	122 67 00 35	£410.00
V. Large (pair)	122 67 00 36	£458.00



Coloured Tropical Fish

Add some extra fun and whimsy to your Bubble Tube with the addition of our realistic tropical fish. Users will enjoy the bright, vibrant colours of the fish as they bob up and down the Bubble Tube, simulating real fish.

Please Note: Types of fish and colours may vary.

Twelve Coloured Tropical Fish
122 02 00 10 **£29.99**

Bubble Tube Bracket

Our handy Bubble Tube wall mounted bracket is recommended to add stability to our Experia Bubble Tubes. This is recommended for use with Bubble Tubes with a height of 1.5m or more. It fastens directly to the wall, with fixtures and fittings supplied. The wall bracket is made from a tough acrylic, giving you peace of mind for added security.

Bubble Tube Brackets
100mm Tubes 122 02 00 03 3 **£38.49**
150mm Tubes 122 02 00 03 1 **£44.99**
200mm Tubes 122 02 00 03 2 **£54.99**
300mm Tubes 122 02 00 03 4 **£65.99**

Bubble Tube Cap

This is a replacement Bubble Tube cap. It is a clear Bubble Tube cap which lets light escape to produce an ethereal rippling effect on the ceiling above. This cap is made from tough acrylic and will fit any Bubble Tube with a 150mm diameter.

Bubble Tube Cap 122 02 00 04 **£21.99**

Bubble Tube Emptying Kit (Foot Pump)

An easy way to remove water from your Bubble Tube. Just apply pressure to the foot pump provided to remove water from the bubble tube. No additional tools are required; it's that simple.

Please Note: This kit includes 6m of hose and a foot pump.

Bubble Tube Emptying Kit (Foot Pump)
122 34 00 06 **£65.99**

BCB – Bubble Tube Cleaner

Keep your Bubble Tube Sparkling Clean. Just add the BCB liquid to any bubble tube to slow the growth of bacteria and algae.

Please Note: A 500ml bottle is supplied and we recommend a 20ml application per month.

BCB Bubble Tube Cleaner
122 33 00 06 **£28.60**

Say hello
to some of
our happy
customers...



LED Bubble Walls



Ideal for when space is limited, our LED Bubble walls are perfect for creating a calm environment for the user, as well as for interaction and stimulation purposes.

An eye-catching addition to any sensory room, our bubble walls create a visually striking feature that users can enjoy. They take up absolutely no floor space and can be mounted in a corridor or even in the classroom; we have a wide range of bubble walls to suit a range of needs and abilities.



Bubble walls have plenty of benefits for users, including visual tracking, auditory awareness, social interaction relaxation and many more.

Made in the UK, all our bubble walls use the very latest LED technology, which makes them super low maintenance, silent and bright.

- Our bubble walls must be mounted to a solid wall and all come complete with fixtures and fittings. They are a strong, easy to clean unit.
- Bubble walls are powered using mains voltage which is transformed to a safer low voltage unless otherwise stated.
- All bubble walls measure 540mm W x 1620mm H x 120mm D.
- All wireless controllers feature Qi charging so there's no battery to change.
- We offer a 3 year warranty on all bubble walls, giving you peace of mind.

Calming LED Bubble Wall

Create a calming environment as this LED Bubble Wall gently scrolls through a range of 8 vibrant colours to relax the user. This is the ideal product if you need to reduce anxiety and stress, or just to create a calm space which soothes the user. Watch as hundreds of colourful relaxing bubbles slowly float up the wall; a wonderful addition to any sensory room.

Calming LED Bubble Wall
122 02 00 05 1 **£1,499.00**

Superactive LED Bubble Wall

This Bubble Wall is perfect for developing key life skills in users of all differing abilities. Using the Wireless Colour Selector, users can choose between a range of 8 colours and can also switch the bubbles on and off at their leisure. This Bubble Wall features a calming mode, which allows the colours to scroll softly to promote a relaxing environment.

Superactive LED Bubble Wall
122 56 00 05 **£1,795.00**

IRiS LED Bubble Wall & Qube Bundle

The perfect interactive bundle to aid in learning and development. This features a super soft multi-coloured IRiS 300mm Qube that when rolled up to a distance of 30m, the colour that's displayed on top of the Qube, is then displayed on the Bubble Wall and also announced on the Recordable Speaker. There's also the option to record additional sounds on the speaker to make the experience more unique and better tailored to the user. It's a fun interactive bundle that users will love to get involved in.

Please Note: This bundle is compatible with any IRiS Talker for added flexibility. The IRiS Qube is powered by a 9v PP3 replaceable battery (supplied) and the IRiS Recordable Speaker and LED Bubble Wall are powered using mains voltage which is transformed to a safer low voltage.

Dimensions:
IRiS Recordable Speaker is:
140mm W x 220mm D x 55mm H
IRiS Qube is: 200mm W x 200mm D x 200mm H

IRiS LED Bubble Wall & Qube Bundle
122 15 00 22 **£2,799.00**



IRiS LED Bubble Wall



Nothing can beat this Bubble Wall; it's the best on the market! A great benefit of this product is that it's part of the state-of-the-art wireless IRiS range, so it can be used in conjunction with a whole range of IRiS products. The IRiS LED Bubble Wall works brilliantly to aid in key life skill development using the range of wireless switches available to the user. This Bubble Wall works well to aid in development of cause and effect skills, along with colour recognition. This Bubble Wall features a calming mode, which allows the colours to scroll softly to promote a relaxing environment. The IRiS LED Bubble Wall can also be controlled by any IRiS Talker (switch), see page 41.

IRiS LED Bubble Wall Inc Fill Kit
122 01 00 47 **£1,899.00**

IRiS+ LED Bubble Wall

The wireless control capabilities with this Bubble Wall mean you can control it wirelessly with almost any mobile device. The IRiS + LED Bubble Wall comes with an easy-to-use free downloadable app which features a comprehensive range of interactive options for users to experience. Features include a range of 8 colour options and 10 switch modes including touch, sound, vibration, rotation and relaxation, meaning the possibilities are endless for exciting and entertaining users across all abilities. The app is available from any App Store and is called Experia IRiS+. This Bubble Tube also aids in development of cause and effect skills, along with colour recognition. It also helps calm users with the soothing colour display to create a relaxed sensory space.

iRiS+ LED Bubble Wall
122 16 00 10 **£2,199.00**

UV Superactive LED Bubble Wall

Designed with visually impaired users in mind, the UV Superactive LED Bubble Wall creates an amazing visual display, best used in a darkened room, featuring brightly coloured bubbling water to create a spectacular centrepiece. Featuring bright UV light which stands out among the darkness, the bubbles swirl around on the wall to create a truly magical sensory experience. Using the battery powered Wireless Colour Selector, users can choose between a range of 8 colours and can also switch the bubbles on and off at their leisure. This Bubble Wall features a calming mode, which allows the colours to scroll softly to promote a relaxing environment.

UV Superactive LED Bubble Wall
122 20 00 46 **£1,649.00**

Deluxe LED Bubble Wall

A truly spectacular sight featuring bright LED lights on either side of the Deluxe LED Bubble Wall creating the illusion of two Bubble Walls in one! This is a brand new product which encourages the development of vocalisation skills in users in an interesting, albeit unusual way. Aesthetically appealing, the Deluxe LED Bubble Wall features 26 different modes to both excite and challenge the user. Users can also create stunning colour variations with the advanced RGBW LEDs and make use of the external microphone which comes with this product.

Deluxe Bubble Wall
122 48 00 69 **£2,495.00**



Fibre Optics



Fibre optics create a fabulous light effect; plus they're tactile and safe to touch.

Made in the UK, our light sources use the latest LED technology which means super bright, vibrant colours without the need for a lamp change!

Choose your level of interaction for our range below.

Skills	Calming LED Lightsource	Interactive LED Lightsource	Superactive LED Lightsource	IRiS LED Lightsource	IRiS + LED Lightsource
Relaxation	✓	✓	✓	✓	✓
Tactile	✓	✓	✓	✓	✓
Cause and Effect		✓	✓	✓	✓
Colour Recognition		✓	✓	✓	✓
Switching Skills		✓	✓	✓	✓
Dexterity		✓	✓	✓	✓
Distraction Therapy	✓	✓	✓	✓	✓
Vocalisation				✓	✓
Gross Motor Skills				✓	✓
Fine Motor Skills				✓	✓
Hand to Eye Coordination				✓	✓
Social Skills				✓	✓
Balance Skills				✓	✓
Group Participation				✓	✓
Tracking Skills				✓	✓

- For all products, unless otherwise stated, a fibre optic light source will be required.
- All light sources are powered using mains voltage which is transformed to safer low voltage unless otherwise stated.
- All wireless controllers feature Qi charging so there's no battery to change.
- 3 Year warranty on light sources, giving you peace of mind.



Calming LED Light Source

Relax the senses with the Calming LED Light Source. A bright LED Light Source which gently moves through a range of eight vivid colours which can be used with any Experia Fibre Optics to create a sense of calm and tranquillity in any sensory room. The simple to use access point with integral fixing screw within this unit allows Experia fibre optic products to be plugged in and tightened with ease.

Dimensions: Compact size - 95mm W x 140mm D x 60mm H

Calming LED Lightsource 122 03 00 33 **£219.00**



Interactive LED Light Source

Created using the latest LED technology, the Interactive LED Light Source is super bright and low profile. Featuring 4 vivid colours, this unit is easily controlled with a modern and stylish wireless switch (provided). This product is ideal to aid in key life skills development.

The slow colour change mode on this unit can be used for interaction and relaxation purposes. It is compatible with the full range of Experia fibre optic items, see pages 24-31. The simple to use access point with integral fixing screw within this unit allows Experia fibre optic products to be plugged in and tightened with ease.

Dimensions: Compact size - 120mm W x 230mm D x 65mm H

Interactive LED Lightsource 122 50 00 16 **£549.00**



Superactive LED Light Source

Created using the latest LED technology, the Superactive LED Light Source features 8 vivid colours, easily controlled with a modern and stylish wireless switch (provided). This product is ideal to aid in key life skills development.

The slow colour change mode on this unit can be used for interaction and relaxation purposes. It is compatible with the full range of Experia fibre optic items, see pages 24-31. The simple to use access point with integral fixing screw within this unit allows Experia fibre optic products to be plugged in and tightened with ease.

Dimensions: Compact size - 120mm W x 230mm D x 65mm H

Superactive LED Lightsource 122 56 00 16 **£599.00**



IRiS LED Lightsource

The choice for professionals. The super-bright IRiS LED Lightsource is easily controlled via any IRiS Talker (switch provided, see page 41) making it the ideal product for development of a variety of key life skills for users. This unit is compatible with the full range of Experia fibre optic items, see pages 24-31. The simple to use access point with integral fixing screw within this unit allows Experia fibre optic products to be plugged in and tightened with ease.

Dimensions: Compact size - 120mm W x 230mm D x 65mm H

IRiS LED Lightsource
122 01 00 33 **£549.00**

Fibre Optic Sideglow

Our brilliantly tactile fibre optic strands burst with spectacular vibrant colours when connected to an Experia LED Lightsource, see page 25-26.

These strands are super tactile, safe to touch and visually stimulating for the user; an absolute must for any sensory environment.

- 1m x 150 Strands** 122 03 00 05 1 **£204.00**
- 1.5m x 100 Strands** 122 03 00 05 2 **£204.00**
- 1m x 100 Strands** 122 03 00 05 3 **£169.50**
- 2m x 100 Strands** 122 03 00 06 1 **£263.00**
- 2m x 150 strands** 122 03 00 06 2 **£295.00**
- 2m x 200 strands** 122 03 00 06 3 **£299.00**
- 3m x 150 strands** 122 03 00 07 1 **£379.95**
- 3m x 200 strands** 122 03 00 07 2 **£478.50**

Fibre Optic Carpet

Watch as the user is absorbed into a magical universe as tiny fibre optics illuminate the black carpet to create a fascinating galaxy of colours. These carpets are available in a wide range of sizes to suit any room. Extremely tactile and engaging, these also come in a calming mode as standard which gently scrolls through eight vibrant colours to relax the senses.

Please Note: You will need a LED Lightsource to use this product, see page 25-26.

- 1m x 1m Fibre Optic Carpet**
122 03 00 11 2 **£175.00**
- 2m x 1m Fibre Optic Carpet**
122 03 00 11 **£350.00**
- 3m x 1m Fibre Optic Carpet**
122 03 00 11 3 **£525.00**
- 2m x 2m Fibre Optic Carpet**
122 03 00 11 5 **£700.00**
- 4m x 1m Fibre Optic Carpet**
122 03 00 11 4 **£700.00**
- Bespoke** 122 03 00 11 1 **POA**

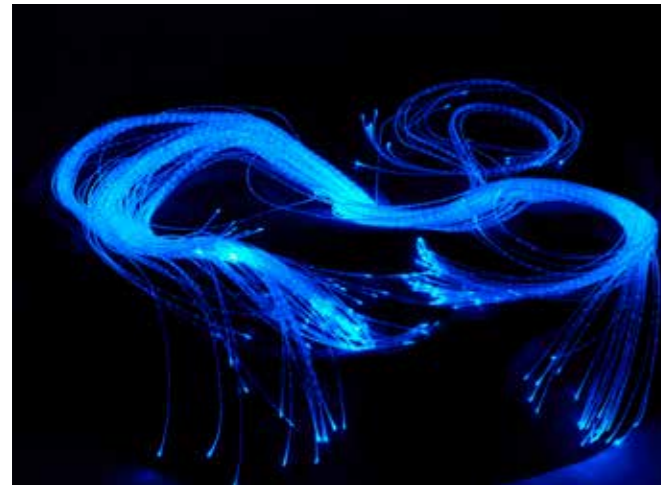

Interactive Fibre Optic Circle Carpet

Step onto the carpet to activate the mesmerising fibre optic lights. These are super simple to use; each carpet contains touch sensitive pressure pads that turn the lights on and off with ease. Extremely tactile and engaging, these also come in a calming mode as standard which gently scrolls through eight vibrant colours to relax the senses.

Please Note: Comes complete with Interactive LED lightsource.

Dimensions: Carpet - 1300mm Sq.

Interactive LED Circle Carpet
122 03 00 02 **£769.00**

Interactive LED Fibre Optic Hand Carpet

A touch sensitive carpet for users to interact with. With this product, users can touch the smooth hand shaped panels for an immediate colour change effect of the stunning fibre optic carpet behind. Users can enjoy the differing textures here with the smooth acrylic hands offering a sharp contrast to the rugged carpet. The Interactive LED Fibre Optic Hand Carpet works brilliantly at developing gross motor and also cause and effect skills.

Please Note: LED lightsource comes with approx 248 strands with 4 colour modes. Hand carpet measures at 1450mm H x 1200mm W x 90mm D.

Interactive LED Hand Carpet
122 03 00 30 **£1759.00**

LED Fibre Optic Wall Carpet

A wall mounted version of the fibre optic carpet that creates a wonderful visual effect for users to enjoy. Extremely tactile and engaging, this soft carpet is the perfect addition to a soft plinth or waterbed. These also come in a calming mode as standard which gently scrolls through eight vibrant colours to relax the senses.

Please Note: LED lightsource comes with approx 372 strands and Wall carpet measures at 1m H x 2m W. Full wall fixing kit is supplied.

LED Fibre Optic Wall Carpet inc Lightsource
122 03 00 32 **£1099.00**



LED Fibre Optic Wall Cascade

A tactile, colourful, dramatic and extremely inclusive fibre optic curtain. Witness a shimmering cascade of colour and light through the 150 extra-long fibre optic strands, which gently moves through eight vibrant colours to create a calming tranquil environment in any sensory room. The great benefit about this product is that it's easily accessible to wheelchair or standing frame users due to the 2500mm strands and pivotal wall mounted bracket. The LED Fibre Optic Wall Cascade can be placed over a doorway or on a wall for a choice of positions best suited to the user.

Please Note: The Fibre Optic Wall Cascade measures at 250mm H x 700mm W x 170mm D (without the strands) and weighs 10.5kg so professional installation is recommended. Due to its weight, this unit must only be mounted on a brick wall or breezeblock wall.

LED Fibre Optic Wall Cascade
122 03 00 28 **£1099.00**



Circular LED Fibre Optic Shower

Imagine a bright light showering down all around you, creating a wonderful sense of calm. The Circular LED Fibre Optic Shower has hundreds of brightly coloured fibre optic strands which surround the user. The great benefit about this product is that it's easily accessible to wheelchair or standing frame users. The product comes complete with a mirrored ceiling panel which creates a wonderful visual effect as users look upwards. These also come in a calming mode as standard which gently scrolls through eight vibrant colours to relax the senses.

Please Note: LED lightsource comes complete with 200 standard 2000mm strands. Fibre optic shelf measures 1200mm in diameter. Full ceiling fixing kit is supplied.

Circular LED Fibre Optic Shower
122 03 00 31 **£1869.00**

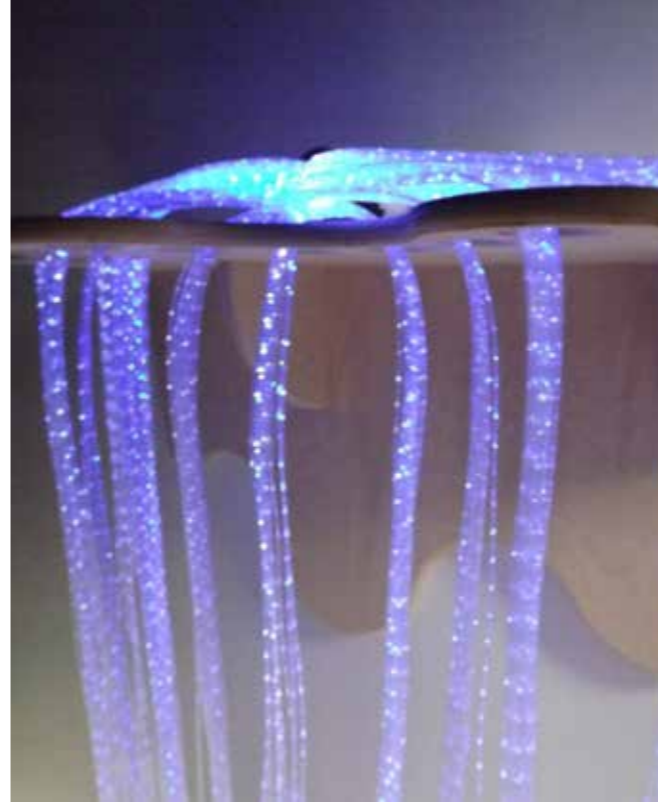

LED Fibre Optic Shimmering Curtain

Watch as the user gets lost in a world of bright shimmering lights draped all around them with the clusters of cascading fibre optics, creating a truly amazing visual light show. This product is available in any standard Experia vinyl colour, giving you the chance to match the product with your room colour, see page 178-179 for more details. These also come in a calming mode as standard which gently scrolls through eight vibrant colours to relax the senses.

Please Note: Shimmering curtain comes complete with 200 standard 2000mm strands and a calming LED lightsource.

Dimensions: Shelf - 1000mm W x 300mm D. Full fixing kit is supplied.

LED Shimmering Curtain
122 03 00 12 **£ 538.00**

Shelf Only 122 03 00 34 **£109.95**



Fibre Optic Plinth

A soft padded plinth which allows users to sit comfortably and hold onto the beautifully bright fibre optic strands that emerge from the side. This product is available in any standard Experia vinyl colour, giving you the chance to match the product with your room colour, see page 178-179 for more details. These also come in a calming mode as standard which gently scrolls through eight vibrant colours to relax the senses.

Please Note: Calming LED lightsource comes complete with 150 standard 2000mm strands. Plinth measures at 400mm H x 300mm W x 300mm D.

Fibre Optic Plinth Set
122 32 00 19 1 **£875.00**

Fibre Optic Wide Bore

The Fibre Optic Bore emits a long light through its length whilst providing a focused light which glows bright at the end of it. These are ideally used in a sensory pool or bath as the extra chunky fibre optic bore looks stunning when illuminated under the water. The Product is sold in metre lengths to accommodate all needs and abilities.

Please Note: An Experia LED Lightsource must be used with this product, see page 25-26.

Fibre Optic Wide Bore (per metre)
122 03 00 09 **£109.00**



Fibre Optic Bundles



IRiS + LED Fibre Optic Bundle

Utilise the wireless capabilities of this bundle and control these fibre optics with your iPad, iPhone or iPod Touch. Featuring simple to use interactive fibre optics with a free downloadable app available from App Store: Experia iRiS+. The app comes with ten modes including touch, sound, vibration, rotation and relaxation. These also come in a calming mode as standard which gently scrolls through eight vibrant colours to relax the senses.

Please Note: LED lightsource is included. Comes with 150 standard 2000mm long strands.

iRiS+ LED Fibre Optics
122 16 00 03

£1429.00

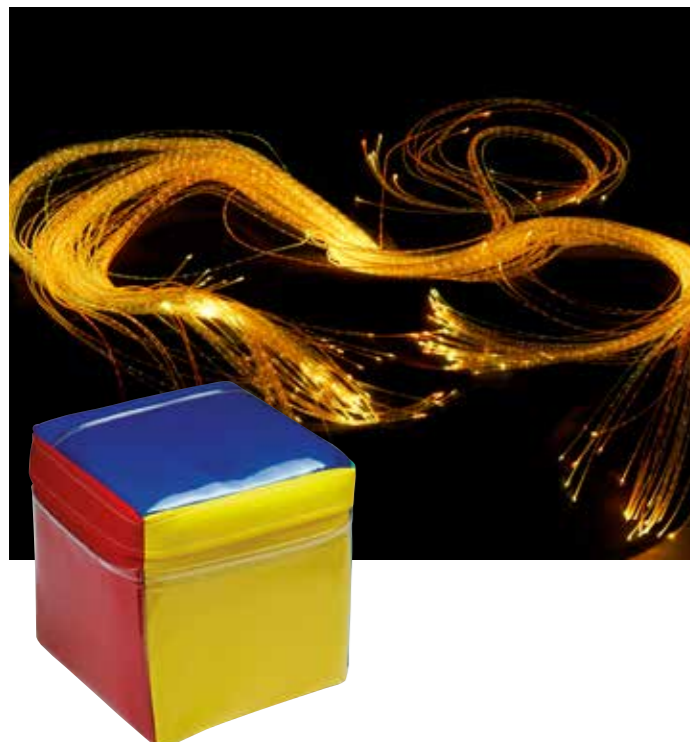

IRiS LED Fibre Optic Qube Bundle

Utilise the wireless capabilities of this bundle and control the fibre optics with the IRiS Qube, just roll the Qube for a colour to appear. This product comes complete with a battery powered IRiS Qube and works with any IRiS talking device (Other IRiS products sold separately) This also comes in a calming mode as standard which gently scrolls through eight vibrant colours to relax the senses.

Please Note: LED lightsource is included and comes with 150 standard 2000mm strands.

iRiS LED Fibre Optic Qube Bundle
122 15 00 12

£1162.00



Superactive LED Fibre Optic Bundle

Utilise the wireless capabilities of this bundle and control the colour of the fibre optics using the battery powered Wireless Colour Selector (provided). This product works really well to aid in users' dexterity skills development. These also come in a calming mode as standard which gently scrolls through eight vibrant colours to relax the senses.

Please Note: LED lightsource comes with 150 standard 2000mm strands.

Superactive LED Fibre Optics
122 15 00 15

£898.00



LED Fibre Optic Softie

Relax and unwind with the calming ambience this fibre optic softie provides. Users can recline into the large bean filled Softie and get up close with an Experia Fibre Optic Sideglow, that gently moves through eight vibrant colours to relax the senses and promote a calming environment. The comfortable Softie is made from soft but durable, wipe-clean fabric that's available in a range of colour options - please state your colour preference when placing your order.

Dimensions: Softie measures 500mm H x 1350mm dia.

Please Note: Each of the substantial 200 strands is 2m long and are illuminated by a standard LED Lightsource.

LED Fibre Optic Softie 122 32 00 16
Softie only 122 32 00 16 1

£861.50
£267.75

Projection



Here at Experia, we offer a unique variety of projectors and accessories that create a striking, visual experience to the user's room. For a sensory room, projection is one of the main three essential components, to help promote a safe, relaxed environment, as well as improving on and encouraging social interaction skills.

All our projectors are powered using mains voltage, which is transformed to a low voltage unless otherwise stated.

For additional safety, we recommend the projector is mounted using an approved Experia Wall Bracket.

Receive a 3 Year Warranty on the Aurora Projector, 1 year warranty on all other products.

	Aurora Projector	Aura Projector	Laser Theatre Projector	Sphere Projector
Suitable for small rooms	✓	✓	✓	✓
Suitable for large rooms	✓		✓	
Integral LED lamp	✓	✓		
Halogen Capsule Bulb				
Wall or ceiling mounted	✓	✓	✓	
Table top mounted	✓	✓	✓	✓
Accessory bundle available	✓	✓		



Aurora LED Projector

The Aurora LED Projector is a silent projector, making it ideal for both the classroom and bedroom. For those rooms that need a silent sensory experience, this projector is the one you need. Its silent appeal means that in those settings where quiet is needed, there are no distractions, just a delightful calming sensory experience for the user.

The robust LED technology of the Aurora Projector requires minimal maintenance without the need for a lamp change and it displays an image that's crystal clear.

Please Note: The Aurora Projector is compatible with all standard accessories such as wheel rotators, effect wheels and effect cassettes*.

*Wheel rotator and effect wheels are required for projector operation; these are available separately or can be purchased as part of a bundle.

Aurora LED Projector 122 23 00 09 **£329.00**
Black Wall Bracket 122 33 00 22 B **£26.39**
White Wall Bracket 122 33 00 22 W **£26.39**

Aurora LED Projector Bundle with 6" Effect Wheels

A brilliant starter bundle to take your sensory room to the next level.

This Bundle Includes:

- Aurora LED Projector
- Wheel rotator and five Experia 6" effect wheels comprising: Balloon Extravaganza, Dawn til Dusk, Firework Bonanza, Outer Space and Tropical Reef.

Aurora Projection Bundle 122 23 00 09 1 **£522.50**
Black Wall Bracket 122 33 00 22 B **£26.39**
White Wall Bracket 122 33 00 22 W **£26.39**

Aura LED Projector

The Aura LED Projector is a compact LED Projector which can be used in small and medium sized sensory rooms. The super bright and robust LED Technology is low maintenance without the need for a lamp change and provides a totally crystal-clear image.

Please Note: The Aura Projector is compatible with all standard accessories such as wheel rotators, effect wheels and effect cassettes*.

*Wheel rotator and effect wheels are required for projector operation; these are available separately or can be purchased as part of a bundle.

Aura LED Projector 122 23 00 07 **£183.00**
Black Wall Bracket 122 33 00 22 B **£26.39**
White Wall Bracket 122 33 00 22 W **£26.39**



Laser Twilight Projector

The Laser Twilight Projector is a stunning star shaped projector, ideal for any sensory room. Imagine a beautiful starry sky being projected onto your walls and ceiling, creating a twinkling twilight experience. The Laser Twilight Projector does just this, and projects star and kaleidoscope effects onto any surface from between 3 metres right up to 30 metres away. The inbuilt green and red lasers, combined with four interchangeable holographic lenses, creates up to 39 different awe-inspiring laser show displays.

Please Note: This Projector can be wall or ceiling mounted and the speed can be controlled for ease of use.

Laser Twilight Projector 122 23 00 66 **£99.00**

Laser Sphere Projector

For a dazzling multi-coloured sensory experience, the Laser Sphere Projector is one to watch. This provides a beautiful kaleidoscope of colours which calm the senses and also creates shapes that dance around the room for hours on end. The versatility of this projector means it can also be used as a night light for a calming lull into sleep. In addition, the cap of this projector is removable, which allows the soft mood lighting to be transformed into an awe-inspiring light show that's projected onto walls and ceilings.

Laser Sphere Projector 122 23 00 68 **£26.95**

Wheel Rotator for 6" Effect Wheels

The Wheel Rotator is an essential, yet welcome addition that ensures the wheels of your projector keep turning smoothly. The Wheel Rotator allows 6" or 9" Effect Wheels to rotate with ease. The 6" is available in a range of 3 speeds of ½ or 5 revolutions per minute (rpm) or 6 minutes per revolution (mpr) and the 9" is available in ½ rpm only. The Wheel Rotator is compatible with all Aurora and Aura Projectors.

6" - ½ rpm 122 23 00 02 1 **£46.25**
6" - 5 rpm 122 23 00 02 2 **£48.45**
6" - 6 rpm 122 23 00 02 3 **£48.45**



Deflective Mirror

Add a new reflective dimension with our Deflective Mirror. With the Deflective Mirror, you can project images up to the ceiling, along the floor and onto the wall to add emphasis to the image. This attaches to the front of all Aurora and Aura projectors.

Deflective Mirror 122 23 00 04 **£75.00**

Panoramic Rotator

Create a 360-degree surround with our Panoramic Rotator. This handy addition enables the projected image to automatically move across the floor, walls and ceiling for a truly spectacular visual effect that's displayed all around the user. This attaches to the front of all Aurora and Aura projectors.

Panoramic Rotator 122 23 00 05 **£97.99**

White Pop-Up Tent

Create a Pop-up landscape that creates the ultimate in sensory experiences. With a White Pop-Up Tent, you can take the user on a journey to enjoy a wonderful sensory experience where they feel like they are inside the image that's been projected onto the tent. This also works well as a safe space area to enable the user to feel comforted and relaxed as they enjoy the calming sensory experience within. The White Pop-Up Tent is super easy to store; just fold it and unfold it in less than a minute and use the handy roll-up door to make the experience complete.

White Pop-Up Tent 122 23 00 65 **£98.45**

Projection Net

The Projection Net is a wonderful tool which you can hang easily from the ceiling with the hoop provided. Projected images onto the net creates a soothing, calming environment which surrounds the user as they sit within gaze upon the beautiful imagery displayed.

Projection Net 122 23 00 64 **£29.39**



6" Effect Wheels and Bundles

Take your senses on a journey with our amazing range of Effect Wheels and Bundles. These Wheels are ideal for telling a story, to calm the user or to create a theme in a sensory room. Enjoy a range of themed wheels which create beautiful imagery from Fireworks to a Tropical Reef to tantalise the senses. Liquid Effects wheels are also available in a range of three colours; these contain oil which moves around – just like a lava lamp, that helps create a calming, serene environment for the user.

Please Note: 6" Effects Wheels and Bundles are compatible with all Aurora, Helios and Aura Projectors. The Wheel Rotator and projector are required to operate; these are available separately.

Bundle Options:
 6" Bundle One - One each of Balloon Extravaganza, Firework Bonanza and Tropical Reef.
 6" Bundle Two - One each of Balloon Extravaganza, Dawn til Dusk, Firework Bonanza, Outer space and Tropical Reef.

All 6" Wheels 122 23 00	£30.99
6" Bundle 1 122 23 00 59	£92.97
6" Bundle 2 122 23 00 60	£126.50
6" Blank Wheel 122 23 00 40	£14.95

6" Experia Effects Wheels - set of 3 230059
Experia 6" Effects Wheels - set of 5 230060

- | | |
|------------------------------------|--------------------------------------|
| Alphabet 230079 | Sports 230058 |
| Aviation 230084 | Transport 230085 |
| Balloon Extravaganza 230038 | Tropical Reef 230042 |
| Bear Hunt 230092 | Under the Sea 230048 |
| Birds of Paradise 230046 | Walk in the Woods 230045 |
| Cityscape 230077 | Whales 230090 |
| Dawn til Dusk 230039 | World 230088 |
| Expressions 230078 | Noisy - Army 230095 |
| Firework Bonanza 230044 | Noisy - Circus 230053 |
| Flower Power 230049 | Noisy - Farm Animals 230051 |
| Force of Nature 230047 | Noisy - In the Garden 230096 |
| Fruit 230080 | Noisy - Jungle 230056 |
| Funky Halloween 230043 | Noisy - Nursery Rhymes 230098 |
| Green 230089 | Noisy - Pirate 230055 |
| London 230086 | Noisy - Princess Power 230097 |
| Numbers 230076 | Noisy - Seaside 230057 |
| Outer Space 230041 | Noisy - Space 230054 |
| People 230091 | Noisy - Transport 230052 |
| Prehistoric 230083 | Noisy - Under the Sea 230094 |
| Rainbow Fish 230093 | |
| Royal 230087 | |
| Santa Journey 230050 | |



Say hello to some of our happy customers...

IRiS™ Interactive Reward System



Our revolutionary IRiS wireless sensory range, allows you to take full control of your sensory room. The Interactive Reward System (IRiS), is operated by switches called Talkers, which communicate with single or multiple pieces of equipment called Listeners.

There are a wide range of Talkers and Listeners available, which increases the options for all IRiS users and makes them accessible for all abilities. With the addition of an IRiS Convertor, any item of our equipment becomes IRiS compatible.

Here are some more great reasons to choose IRiS:

Completely wireless

IRiS products use the latest interactive technology and can be positioned anywhere within a room. This means maximum user comfort and ensures an enjoyable experience every time.

Flexible and user friendly

Our IRiS products are designed to adapt to any individual, making them accessible to any age or ability. There is a Talker and a Listener which can accommodate every user.

Expand and upgrade

The IRiS Talkers can control any number of IRiS Listeners, which gives you full flexibility to create a new sensory room experience whenever you wish. This can be done quickly and easily to offer you full versatility within the room. New IRiS items can be added at any point. For example, as funding becomes available.

IRiS - put more control in your hands.

We are delighted that our IRiS iConvertor with free IRiS+ App is now available. This allows you to control the equipment in any multisensory room, using any mobile device. Any IRiS Listener can now be controlled using the IRiS technology via touch, voice, vibration or rotation. Making them completely accessible and allowing more flexibility for more users.



It's as easy as ABC:

A.

Assess

Assess the needs of the individual skills you wish to develop.

B.

Build

Build your collection of IRiS Talkers best suited to your users and their development programme.

C.

Control

Control the IRiS Listeners that suit your users best and just get started. It is the perfect way to develop life skills while having fun.



IRiS+®

A full range of interactive switches in an app

Control your sensory equipment by iPad, iPhone or iPod touch.

The power of the iPad® is changing lives, particularly for those with special needs. We're delighted to strengthen this with the introduction of our ground-breaking IRiS+ app, designed specifically to enable the end user to easily control a multisensory room.

This unique app opens up a whole new world of interaction, learning and development and is probably the easiest and most advanced control switch on the market. It's extremely powerful, offering seven control switches in one, spanning touch, sound, vibration and movement.

It's also incredibly cost effective. The full IRiS+ app is completely FREE to download and by doing so you can control either one or a number of our multi-sensory products in a variety of ways.

Touch

Multiple Buttons Mode: Choose between two, four and eight switches to control the equipment depending on the user's ability. It also has eight switching modes to develop different switching skills.

Single Button Mode: A single button which controls sensory equipment. Also includes four modes to develop switching skills.



Sound

Controls sensory equipment via sound. Just talk, shout or clap your hands to control equipment. Includes four modes to develop switching skills.

Vibration

Move the iPad®, iPhone® or iPod Touch® to control sensory equipment. Includes four modes to develop switching skills.

Rotation

Turn the iPad®, iPhone® or iPod Touch® onto different sides to control sensory equipment. Includes four switching modes to develop switching skills.

Compass Mode

Turn the iPad®, iPhone® or iPod Touch® through 360 degrees to control sensory equipment. Includes two modes to develop switching skills.

Relaxation

Promotes calming and relaxation by slowly changing the coloured lighting emitted from equipment. The speed of colour change is also controllable.

Scanner Touch Mode

A scanner is controlled by dragging a circle around on the screen. It has the follows functions

Scrolling Start - colours change while you move scanner, otherwise they stay on last colour. **Scrolling Stop** - colours change when you don't move scanner, otherwise they stay on last colour.

Scrolling Momentary - colours change when you move the scanner, otherwise the light is switched off.

Scanner Tilt Mode

A scanner is controlled by tilting the device.

Scrolling Start - colours change while you move scanner, otherwise they stay on last colour. **Scrolling Stop** - colours change when you don't move scanner, otherwise they stay on last colour.

Scrolling Momentary - colours change when you move the scanner, otherwise the light is switched off.

Orientation Mode

This can be set to Hand Held, Arm mounted or Head mounted

IRiS Talkers

The comprehensive range of IRiS Talkers combine the very best in tactile properties and the latest digital technology with an option to suit the needs of every user.

Skills	IRiS iConverter	IRiS Cube	IRiS Colour Selector	IRiS Colour Selector Deluxe	IRiS Switchbox	IRiS Single Switch	IRiS Soundswitch	IRiS Light Wand	IRiS Floating Switch	IRiS Soft Switch	IRiS Balance Beam
Tactile	✓	✓	✓	✓	✓	✓	✓	✓	✓	✓	✓
Cause and Effect	✓	✓	✓	✓	✓	✓	✓	✓	✓	✓	✓
Colour Recognition	✓	✓	✓	✓	✓	✓				✓	✓
Switching Skills	✓		✓	✓	✓			✓			
Dexterity	✓	✓	✓	✓	✓	✓		✓	✓	✓	✓
Vocalisation	✓						✓				
Gross Motor Skills	✓	✓	✓	✓	✓				✓	✓	✓
Fine Motor Skills	✓		✓	✓	✓	✓		✓			
Hand to eye coordination	✓		✓	✓	✓			✓			
Social Skills			✓	✓	✓						
Balance Skills											✓
Group Participation	✓	✓	✓	✓	✓					✓	
Tracking Skills	✓							✓			

- Wireless controllers feature Qi charging so there's no battery to change unless stated otherwise.
- Housed in a tough, easy to clean enclosure.
- 3 Year warranty on all products, giving you peace of mind.
- An IRiS Listener is required to use with this product.



IRiS+ iConvertor

Control any IRiS Listener with your iPad, iPhone or iPod Touch.

Regardless of age, any IRiS Listener can be controlled using the iConvertor and the free downloadable app that's available from your App Store: Experia iRiS +.

The App comes with six modes including touch, sound, vibration, rotation and relaxation.

IRiS+™iConvertor 122 01 00 73 **£703.00**



IRiS Colour Selector

A light, durable and compact Talker, the perfect product for building essential skills.

This unit is ideal for improving colour recognition, along with cause and effect skills. It features 8 colour coded 3.5mm jack sockets which allow external switches to be connected for extra control. The unit operates from a distance of up to 30m, making it suitable for even large sensory spaces.

Please Note: Compact size of 65mm D x 240mm W x 190mm H enabling easy storage. Powered by four AA batteries (supplied) which are easy to change.

IRiS Colour Selector 122 01 00 42 1 **£384.00**



IRiS Qube

A fully interactive and fun way to control sensory equipment. This product is a super-soft multi-coloured IRiS Qube that, when rolled from a distance of up to 30m, displays the colour on the top by any IRiS Listener.

The clear sleeves on the IRiS Qube allow an item or image of your choice to be inserted, making it easy to tailor specifically to your organisation.

Please Note: The IRiS Qube is powered by a 9v PP3 replaceable battery (supplied) and is available in two sizes: 200mm square or 300mm square.

IRiS Qube 200mm 122 01 00 03 3 **£318.00**
IRiS Qube 300mm 122 01 00 03 4 **£329.00**



IRiS Colour Selector Deluxe

Ideal for developing switching skills.

The IRiS Talker comes with eight comprehensive modes: 'locked', 'toggle', 'momentary', 'racing', 'passive', 'timed', 'scroll stop' and 'scroll next'. See the Mode Guide for an explanation of these.

It features 8 colour coded 3.5mm jack sockets which allow external switches to be connected for extra control. The unit operates from a distance of up to 30m, making it suitable for even large sensory spaces.

Its compact size also makes for easy storage.

Dimensions: 65mm D x 240mm W x 190mm H.

IRiS Colour Selector Deluxe
122 01 00 62 1 **£714.00**

IRiS Qube & Recordable Speaker

A fully interactive and fun way to control sensory equipment. This product is a super-soft multi-coloured IRiS Qube that, when rolled from a distance of up to 30m, displays the colour on the top by any IRiS Listener and is also announced by the IRiS Recordable Speaker.

The Recordable Speaker includes 64 pre-recorded sounds, musical clips and noises with the option to add another sixteen sounds, making it very specific to the user's needs. The clear sleeves on the IRiS Qube allow an item or image of your choice to be inserted, further tailoring it specifically for your organisation.

Please Note: IRiS Qube is powered by a 9v PP3 replaceable battery (supplied) and this is available in two sizes: 200mm square or 300mm square. The IRiS Recordable Speaker is 220mm D x 140mm W x 55mm H.

IRiS Qube (300mm) inc Recordable Speaker
122 010003 1 **£624.00**
IRiS Qube (200mm) inc Recordable Speaker
122 010003 2 **£604.00**



IRiS Switchbox

The perfect solution for improving motor skills or hand-to-eye coordination.

This product features a touch-sensitive IRiS Talker; simply press one of the large coloured panels to control any IRiS Listener.

The IRiS Switchbox has eight modes: 'locked', 'toggle', 'momentary', 'racing', 'passive', 'timed', 'scroll stop' and 'scroll next'. See the Mode Guide for an explanation of these. The unit is supplied with an eight switch overlay with optional one, two or four way switch overlays also available.

The Switchbox operates from a distance of up to 30m, making it suitable for even large sensory spaces. It also has an ergonomic sloping top, meaning it's ideal for use on laps and table tops.

Dimensions: 330mm D x 565mm W x 85mm H.

Please Note: It is powered by six AA batteries (supplied), which are easy to change.

IRiS Switchbox 122 01 00 01 **£1319.00**
Switchbox Overlays - Set of 3
122 01 00 02 **£131.00**



IRiS Single Switch

Ideal to develop cause and effect skills. The IRiS Single Switch is a great choice where simplicity in use is the key. It can be used to change the colour of any IRiS Talker with the press of one large button. This product comes with a handy 3.5mm jack socket which allows an external switch to be connected for alternative control. It operates from a distance of up to 30m making it suitable for even large sensory spaces. The IRiS Single Switch is chunky in size with a sloping top, making it easy to grip for the user.

Dimensions: Chunky size: 220mm D x 140mm W x 75mm H.

Please Note: It is powered by four AA batteries (supplied) which are easy to change.

IRiS Single Switch 122 01 00 43 1 **£274.00**

IRiS Soundswitch

Control any IRiS Listener with the sound of your voice. This Ultra-sensitive IRiS Soundswitch is a voice activated Talker which can control any IRiS Listener. It encourages vocalisation skills with its four switching modes: 'locked', 'momentary', 'scrolling' and 'sound responsive'. See the Mode Guide for an explanation of these. The Sensitivity controller allows the Soundswitch to be easily adjusted for all users. It operates from a distance of up to 30m, making it suitable for even large sensory spaces. The unit has the option of using the inbuilt microphone or a jack for an external microphone (not supplied). It's also compact in size and super tactile, meaning it's easy to move around to suit the user's needs.

Dimensions: Compact size: 150mm D x 100mm W x 55mm H.

IRiS Soundswitch 122 01 00 05 1 **£494.00**
External Microphone 122 49 00 02 **£65.99**

IRiS Light Wand

A versatile Talker for developing tracking skills or fine and gross motor skills. The IRiS Light Wand has been developed to work with the IRiS Scanner and communicates wirelessly; simply move the sensitive joystick and watch the IRiS Scanner follow every move you make. This includes a large colour change switch which alters the colour or shape from the IRiS Scanner. It also operates from a distance of up to 30m, making it suitable for even large sensory spaces. This product comes with a handy 3.5mm jack socket, which allows an external switch to be connected for alternative control. Its chunky size with a sloping top makes it easy to grip for users.

Dimensions: 220mm D x 140mm W x 75mm H.

Please Note: Powered by four AA batteries (supplied) which are easy to change.

IRiS Light Wand 122 01 00 07 **£439.00**

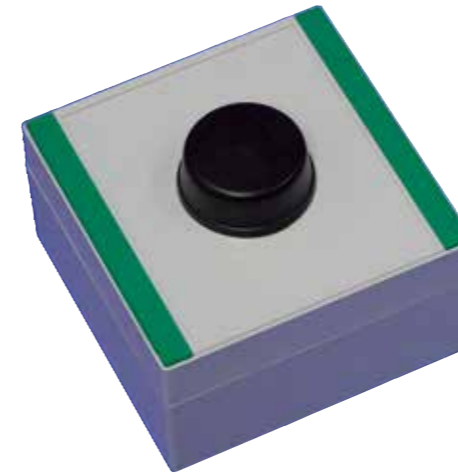

IRiS Floating Switch

A waterproof switch that can be safely immersed in water whilst in use. The IRiS Floating Switch is a wireless IRiS Talker with one easy to press button; it's completely safe for use in swimming pools and bathrooms with IRiS Listeners. This unit is particularly suited to the IRiS Shape Projector and IRiS Light Spreader to create a unique and magical environment for the user. It operates from a distance of up to 30m, making it suitable for even large sensory spaces. Its large square shape makes it easy to store and find.

Dimensions: 160mm D x 160mm W x 90mm H

Please Note: Powered by four AA batteries (supplied), which are easy to change.

IRiS Floating Switch 122 01 00 10 **£461.00**

IRiS Soft Switch

Take interaction into the soft play room. A fun addition for any soft play room; this features a huge switch with eight large and brightly coloured sections that control any IRiS Listener. This unit is perfect for aiding in development of gross motor skills and colour recognition and is available in one or two pieces. It is covered in a soft, durable and easy-to-clean vinyl, making it fit for purpose. It operates from a distance of up to 30m, making it suitable for even large soft play areas.

Dimensions: One Piece Unit - 2000mm W x 650mm D x 500mm H.
 Two Piece Unit - 2 x 1000mm W x 650mm D x 500mm H.

Please Note: Powered by four AA batteries (supplied), which are easy to change.

IRiS Soft Switch - One Piece Unit
 122 01 00 32 **£1649.00**

IRiS Soft Switch - Two Piece Unit
 122 01 00 31 **£1649.00**

IRiS Balance Beam

Add a new dimension to improve balance, coordination, gross motor skills and colour recognition skills. The IRiS Balance beam adds an extra level of interaction to your soft play area, where users can stand on any of the 8 large and brightly coloured sections and control any IRiS Listener. It's covered in a soft, durable and easy-to-clean vinyl, making it fit for purpose. When complete, the IRiS Balance Beam measures 2000mm D x 450mm W x 400mm H. It operates from a distance of up to 30m, making it suitable for even large soft play areas.

Please Note: Powered by four AA batteries (supplied) which are easy to change.

IRiS Balance Beam
 122 01 00 40 **£1649.00**



IRiS Mode Guide



Thoroughly researched and carefully designed switch modes to help develop key lifeskills.

Locked - Press any coloured switch and the listener changes to that colour and stays on it until a different switch is touched. The listener then changes to the new colour.

Toggle - Press any coloured switch and the listener changes to that colour. Press any coloured switch again and the light goes out.

Momentary - Press any coloured switch and any listener paired to the unit will change to that colour. The moment you stop pressing the switch, the lights go out.

Racing - This mode operates like a quiz buzzer. The first coloured button pressed illuminates the listener and stops any other switch action. After five seconds the colour goes out and it is ready to start again.

Passive - The listeners paired to the unit start slowly changing colour. Ideal for a relaxation session.

Timed - Press any coloured switch and any listener paired to the unit will change to that colour for a preset time. The time is fully adjustable by pressing the 'Time' switch on the unit. Each time you press the 'Time' switch the time increases. Times available are: 1, 2, 3 4, 5, 10, 15, 20, 25, 30, 40, 50, 60 seconds.

Scrolling Stop - The listeners paired to the unit start changing colour. When any switch is pressed they stop on the colour illuminated at that point. The listener stays on that colour for a preset time. The time is fully adjustable by pressing the 'Time' switch on the unit. Each time you press the 'Time' switch the time increases. Times available are: 1, 2, 3 4, 5, 10, 15, 20, 25, 30, 40, 50, 60 seconds.

Scrolling Next - When any coloured switch is pressed the listeners paired to the unit will scroll to the next colour.

Scrolling - IRiS Listeners paired to the unit start slowly changing colour. When a sound is detected the unit stops on the colour that was illuminated at that point. If you make a sound constantly the unit will continue to stay on that colour. When a sound is not detected the unit will begin changing colour again.

Sound Responsive - The IRiS Listener will change colour whenever a sound is heard.

IRiS Listeners

This unrivalled range of IRiS Listeners have been thoughtfully designed to work seamlessly with the IRiS range of Talkers. The emphasis throughout is to engage the user with scope to easily upgrade the range to add new items when required to give extra dimensions to the learning and development experience.

	IRiS LED Infinity Tunnel	IRiS LED Infinity Tunnel	IRiS Soundboard	IRiS LED Colour Panel	IRiS Musical Touchwall	IRiS Sensory Ceiling	IRiS LED Strip	IRiS Recordable speaker	IRiS Jet Stream	IRiS Soft Jet Stream	IRiS Convertor
Sound			✓		✓			✓	✓	✓	✓
Touch			✓		✓					✓	
Movement	✓	✓	✓	✓	✓				✓	✓	
Light	✓	✓	✓	✓	✓	✓	✓				✓
Texture										✓	
Colour	✓	✓	✓	✓	✓	✓	✓				✓
Customisable			✓					✓			
Available in a bundle			✓					✓			

	IRiS LED PAR CAN	IRiS LED Pinspot	IRiS LED Ripple Light	IRiS LED Scanner	IRiS LED Light Spreader	IRiS LED Light Source	IRiS Fogger	IRiS LED Fibre Optic Wall Cascade	IRiS LED Fibre Optic Wall Carpet	IRiS LED Fibre Optic Shower	IRiS LED Bubble Tube	IRiS LED Bubble Wall
Sound											✓	✓
Touch								✓	✓	✓	✓	✓
Movement	✓	✓	✓	✓	✓	✓		✓	✓	✓	✓	✓
Light	✓	✓	✓	✓	✓	✓		✓	✓	✓	✓	✓
Texture							✓	✓	✓	✓		
Colour	✓	✓	✓	✓	✓	✓		✓	✓	✓	✓	✓
Customisable							✓					
Available in a bundle											✓	✓

- All products are powered using mains voltage unless otherwise stated.
- 3 Year warranty on all products, giving you peace of mind.
- An IRiS Talker is required to use with this product.



IRiS LED Infinity Tunnel

Marvel at the seemingly never ending lights with the IRiS LED Infinity Tunnel.

This Tunnel creates an amazing illusion of lights that slowly change colour and continue into the distance forever making it a great favourite with all ages and abilities. This also helps promote a calming and relaxed atmosphere for users. The unit is great at developing colour recognition and switching skills and is easily controlled by any IRiS Talker.

Dimensions: Compact - 520mm W x 135mm D x 580mm H.

Please Note: While the unit is portable, we recommend wall mounting as all fittings are included.

IRiS LED Infinity Tunnel 122 01 00 57 **£1099.00**

IRiS LED Infinity Tunnel - 3 Shapes

Create a stunning focal point in any sensory space that promotes a calm and relaxed atmosphere.

Featuring a super wide set of 3 LED Tunnels in one displaying a circle, square and triangle, this is perfect for both individual and group use and aids in development of social interaction and colour recognition.

The unit is easily controlled by any IRiS Talker and users can control the shapes and lights on show.

Dimensions: 1520mm W x 135mm D x 520mm H.

Please Note: While the unit is portable, we recommend wall mounting as all fittings are included.

IRiS LED Infinity Tunnel 122 01 00 65 **£1539.00**

IRiS Soundboard

Customisable sounds and images at the touch of a button.

The IRiS Soundboard is ideal for aiding in development of sound and language skills with groups or individuals and works with any IRiS Talker.

It comprises 8 frames which illuminate and play one of 8 pre-recorded sounds when the button below it is pressed.

The Soundboard includes 64 pre-recorded sounds, musical clips and noises, with the option to specifically tailor another 16 sounds or messages, making it unique to your requirements.

This is available individually or as part of a bundle with the IRiS Qube to give more fun to learning.

Dimensions: 1380mm W x 130mm D x 820mm H.

Please Note: While the unit is portable, we recommend wall mounting as all fittings are included.

IRiS Soundboard
122 01 00 69 **£1154.00**

IRiS Soundboard & Qube Bundle
122 01 00 70 **£1429.00**

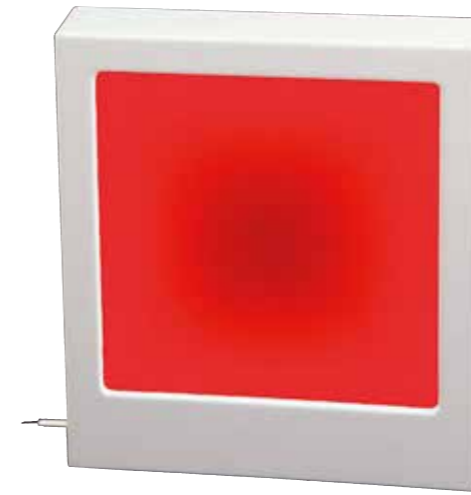

IRiS LED Colour Panel

Promotes a calming and relaxing effect when combined with any IRiS Listener.

The IRiS LED Colour Panel produces slowly changing colours to create a calm atmosphere and is ideal for developing colour recognition and switching skills, which are all controlled by any IRiS Talker.

Dimensions: Compact - 520mm W x 135mm D x 580mm H.

Please Note: While the unit is portable, we recommend wall mounting as all fittings are included.

IRiS LED Colour Panel 122 01 00 59 **£989.00**

IRiS Musical Touch Wall

The IRiS Musical Touch wall is a unique, state-of-the-art developmental tool, jam packed with 11 carefully created modes specifically designed to develop a range of life-skills, through visual stimulation in response to touch.

Ideal for use within a school setting, hospital, day care centre, children's nursery or assessment centre, this unit creates a visually stimulating experience that appeals to users of all ages and abilities.

It's also really easy to use. Just select your own combination of mode (shape), speed, sensitivity and fade using the control panel and create lots of different beautiful effects and challenges as the user moves their hand across the front of the unit.

This unit is controllable remotely from any IRiS Talker.

Dimensions: 520mm W x 135mm D x 580mm H.

Please Note: While the unit is portable, we recommend wall mounting as all fittings are included.

IRiS Musical Touch Wall
122 01 00 80 **£3,075.00**



IRiS Sensory Ceiling

Encourage users to control the colour of the sensory ceiling with the IRiS Colour Selector provided or alternatively any other IRiS talker from the IRiS range.

The IRiS Colour Selector lets users choose from 8 vibrant colours and the IRiS Sensory Ceiling also features a calming mode which gently scrolls through the vibrant colour variations. This comes in a range of 6 diverse patterns and shapes to choose from.

Please Note: Each Sensory Ceiling tile measures at 595mm x 595mm.

Ceiling Panel - Set of 2 - IRiS
122 52 00 09 **£1,020.00**

Ceiling Panel - Set of 4 - IRiS
122 52 00 10 **£1,649.00**

Ceiling Panel - Set of 6 - IRiS
122 52 00 11 **£2,418.00**

Ceiling Panel - Set of 8 - IRiS
122 52 00 12 **£3,298.00**



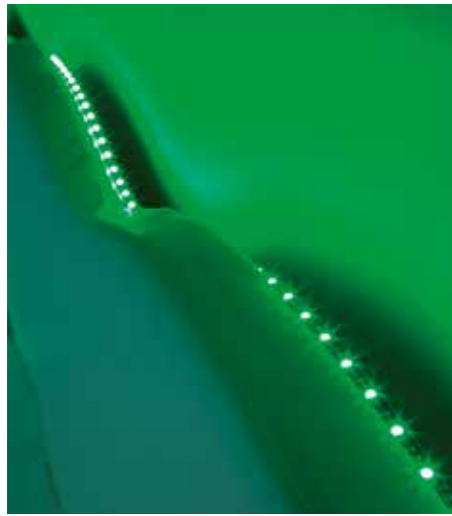

IRiS LED Strip

A great lighting addition for theming, storytelling and developing colour recognition skills. This is an extra-long 3m strip with ultra-bright LED lights to wash an area with bright and intense colours, creating a wonderful ambience and theatrical effect. Use it with the IRiS Colour Selector to easily control the lights to keep an audience enthralled and engaged.

IRiS LED Strip Driver inc LED Strip
122 01 00 63 2 **£769.00**

IRiS Master Pairer

Make your IRiS equipment function in inaccessible rooms. This is the ideal resource if one IRiS Listener is physically inaccessible. The IRiS Master Pairer allows an IRiS Talker to be paired with an IRiS Listener from a convenient location. These units are available in a six or ten way and are powered by wireless charging.

IRiS Master Pairer - 6 Way
122 01 00 11 1 **£549.00**
IRiS Master Pairer - 10 Way
122 01 00 12 1 **£989.00**

IRiS Recordable Speaker

Make your IRiS Talker speak to create a theme for learning, play or storytelling. This is an essential resource to combine with any IRiS Talker to make it speak, either with a pre-recorded sound or one of your choice. The IRiS Recordable Speaker includes 64 pre-recorded sounds, musical clips and noises with the option to add another 16 sounds, making it very specific to the user's needs. Combine it with the IRiS Qube to announce the colour on the top or press a button on the IRiS Colour Selector and the name is emitted from the speaker.

Dimensions: 220mm D x 140mm W x 55mm H.

IRiS Recordable Speaker
122 01 00 04 **£357.50**

IRiS Jet Stream

Easy to control and ideal for users with impaired or limited vision. The IRiS Jet Stream aids the development of cause and effect skills and can be used with any IRiS Talker to change the speed of the fan. This unit is small but mighty, offering a compact and portable design.

Dimensions: 410mm W x 180mm D x 410mm H.

Please Note: While the unit is portable, we recommend wall mounting as all fittings are included. An IRiS Talker is required for use with this product.

IRiS Jet Stream 122 01 00 29 **£1649.00**
Black Wall Bracket 122 33 00 22 B **£26.39**
White Wall Bracket 122 33 00 22 W **£26.39**



IRiS Soft Jet Stream

Let users enjoy the breeze safely to develop cause and effect skills. The IRiS Soft Jet Stream is a floor-based fan allowing users to safely get closer to the breeze that's generated and aids in development of cause and effect skills. The unit housing is made from strong plywood and covered in soft, durable and easy to clean vinyl. Please state your choice of colour when ordering. The fan is protected by a tough steel mesh making it safe to use. The IRiS Soft Jet Stream can be used with any IRiS Talker to change the speed of the fan to enhance the experience. This is suitable for any sensory or soft play area.

Dimensions: 520mm W x 800mm D x 520mm H.

IRiS Soft Jet Stream 122 01 00 30 **£1759.00**

IRiS Convertor

Make all of your products IRiS compatible. Simply connect the IRiS Convertor into a 240v mains socket and plug your chosen item in. This gives added versatility to the IRiS product range in a sensory space.

IRiS Convertor 122 01 00 26 **£252.00**

IRiS LED PAR CAN

Bathe your sensory room completely in bright colourful light with the IRiS LED Par Can. This will bring colour to every corner of your room. The IRiS LED Par Can has intensively bright LEDs which can scroll through a range of eight colour choices and allows much larger spaces to be lit with ease. This is ideal for developing users' colour recognition and visual stimulation. The range of program settings can be made through an integral control and the unit also responds to sound, making the sensory experience even better. This unit is particularly suitable for use in a soft play environment with the IRiS Balance Beam to develop colour recognition, balance and visual stimulation while having fun. Users can also enjoy the IRiS Floating switch combined with multiple IRiS LED Par Cans to flood a pool with colour.

Please Note: While the unit is portable, we recommend wall mounting as all fittings are included. Wall bracket is sold separately.

IRiS LED Par Can
122 01 00 16 **£795.00**
Black Wall Bracket
122 33 00 22 B **£26.39**
White Wall Bracket
122 33 00 22 W **£26.39**





IRiS LED Pinspot

The IRiS LED Pinspot changes colour whenever an IRiS Talker is activated.

Used to develop cause and effect, colour recognition and many other lifeskills. This Pinspot also requires absolutely no maintenance, meaning it's totally fuss free.

Please Note: The LED Pinspot comes complete with a fixed mains lead. Wall bracket is sold separately.

IRiS LED Pinspot 122 01 00 23	£582.00
Black Wall Bracket 122 33 00 22 B	£26.39
White Wall Bracket 122 33 00 22 W	£26.39



IRiS LED Ripple Light

A Rippling water effect is all you'll need to calm the senses. The LED Ripple Light creates a water-like ripple effect which moves through a range of eight colours automatically and helps create a calming, relaxed environment for the user. This requires absolutely no maintenance, so is totally fuss free. This unit is ideal for developing cause and effect skills, switching skills and colour recognition.

Please Note: The LED Ripple Light comes complete with a fixed mains lead and while the unit is portable, we recommend wall mounting as all fittings are included. Wall bracket is sold separately.

IRiS LED Ripple Light 122 01 00 18	£604.00
Black Wall Bracket 122 33 00 22 B	£26.39
White Wall Bracket 122 33 00 22 W	£26.39

IRiS LED Scanner

A brilliant way to develop tracking skills in a fun way. The IRiS LED Scanner is an excellent resource to aid in development of colour and shape recognition, cause and effect skills, hand to eye coordination and tracking skills. This unit produces a range of eight bright colours and shapes including triangles, squares, circles and rectangles. While the IRiS LED Scanner can be used with any IRiS Talker, we recommend the IRiS Light Wand in particular to allow these colours and shapes to be moved around a room easily.

Please Note: Wall bracket is sold separately.

IRiS LED Scanner 122 01 00 21	£1648.00
Black Wall Bracket 122 33 00 22 B	£26.39
White Wall Bracket 122 33 00 22 W	£26.39



IRiS LED Light Spreader

Flood your sensory room with light and develop key life skills with the IRiS LED Light Spreader.

The unit casts a choice of 8 wide circles of beautifully bright colours. When used with the IRiS Colour Selector, users can develop colour recognition and colour matching skills. Alternatively, this unit can be used with the IRiS Soundswitch for vocalisation and switching skills.

Using the very latest LED technology, the Light Spreader is super efficient and can either be wall or ceiling mounted.

Please Note: The wall bracket is sold separately.

IRiS LED Light Spreader 122 01 00 46	£549.00
Black Wall Bracket 122 33 00 22 B	£26.39
White Wall Bracket 122 33 00 22 W	£26.39

IRiS LED Lightsource

The choice for professionals.

The super-bright IRiS LED Lightsource is easily controlled via any IRiS Talker (switch provided, see page 41) making it the ideal product for development of a variety of key life skills for users.

This unit is compatible with the full range of Experia fibre optic items, see pages 24-31.

The simple to use access point with integral fixing screw within this unit allows Experia fibre optic products to be plugged in and tightened with ease.

Dimensions: Compact size - 120mm W x 230mm D x 65mm H.

IRiS LED Lightsource 122 01 00 33	£549.00
--	----------------

IRiS Fogger

The IRiS Fogger is an excellent sensory tool which creates an amazing 3D atmosphere.

When used with any focussed light product of the IRiS range, users can enjoy a stunning display featuring beams of light which are streamed all around them, allowing the user to reach out and touch them. This is a true sensory experience that captures the imagination and creates a calming, ethereal atmosphere.

The Fog unit uses water based fog fluid, which is available separately and creates a totally harmless fog. This means it is suitable for even those with respiratory needs and can be enjoyed by everyone.

It's very simple to use and is controlled by an IRiS Talker, making it easy to integrate into an IRiS equipped sensory space.

Please Note: The Wall bracket is sold separately.

IRiS Fogger 122 01 00 19	£582.00
5L Fog Fluid 122 33 00 07	£21.99
Black Wall Bracket 122 33 00 22 B	£26.39
White Wall Bracket 122 33 00 22 W	£26.39





IRiS LED Fibre Optic Wall Cascade

A tactile, colourful, dramatic and extremely inclusive fibre optic curtain.

Witness a shimmering cascade of colour and light through the 150 extra-long fibre optic strands (easily changed using any IRiS Talker), which gently moves through eight vibrant colours to create a calming tranquil environment in any sensory room. The great benefit about this product is that it's easily accessible to wheelchair or standing frame users due to the 2500mm strands and pivotal wall mounted bracket.

The LED Fibre Optic Wall Cascade can be placed over a doorway or on a wall for a choice of positions best suited to the user.

Please Note: The Fibre Optic Wall Cascade measures at 250mm H x 700mm W x 170mm D (without the strands) and weighs 10.5kg so professional installation is recommended.

IRiS LED Fibre Optic Wall Cascade
122 01 00 61 **£1264.00**



IRiS Circular LED Fibre Optic Shower

Imagine a bright light showering down all around you, creating a wonderful sense of calm.

The IRiS Circular LED Fibre Optic Shower has a 900mm wide circle of 150 brightly coloured fibre optic strands which surround the user. The great benefit about this product is that it's easily accessible to wheelchair or standing frame users.

The product comes complete with a mirrored ceiling panel which creates a wonderful visual effect as users look upwards. These also come in a calming mode as standard which gently scrolls through eight vibrant colours to relax the senses.

Please Note: This comes complete with 150 standard 2000mm strands and is controllable by any IRiS Talker. Fibre optic shelf measures 1200mm in diameter. Full ceiling fixing kit is supplied and professional installation is recommended.

IRiS Circular LED Fibre Optic Shower
122 01 00 68 **£1979.00**

IRiS LED Fibre Optic Wall Carpet

Control this wonderfully tactile and engaging product with any of our IRiS Talkers.

This wall mounted version of our fibre optic carpet that creates a wonderful visual effect for users to enjoy.

Dimensions: Wall carpet measures at 2000mm x 1000mm.

Please Note: While the unit is portable, we recommend wall mounting as all fittings are included.

IRiS LED Fibre Optic Wall Carpet
122 01 00 72 **£1318.90**

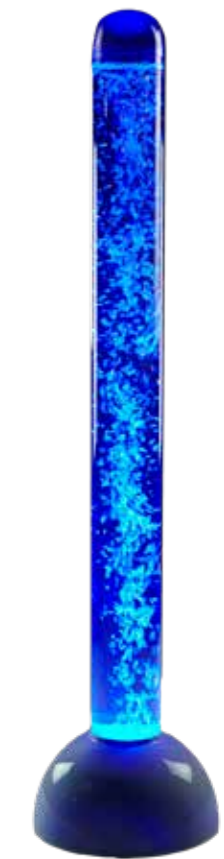

IRiS LED Bubble Tube

If you want the best of the best, this is it!

The IRiS LED Bubble Tube is a key part of the state-of-the-art wireless IRiS range; this means it works in conjunction with a large range of additional IRiS products.

Users can develop key life skills with the range of wireless switches available with this product. The Bubble Tube can also be controlled by any IRiS talker (switch), available separately, see page 41.

An essential addition for any sensory room, bedroom or learning environment.

The IRiS LED Bubble Tube features a beautiful display of calming water, invigorating bubbles and a range of 8 coloured lights encased within a durable and large 150mm wide tube.

This Bubble Tube also aids in development of cause and effect skills, along with colour recognition. It also helps calm users with the soothing colour display used in calming mode.

Please Note: This Bubble Tube is 150mm in diameter.

IRiS LED Bubble Tube - 1 Metre
122 01 00 13 1 **£1,209.00**

IRiS LED Bubble Tube - 1.5 Metre
122 01 00 13 2 **£1,264.00**

IRiS LED Bubble Tube - 2 Metre
122 01 00 13 3 **£1,319.00**

Bubble Tube Bracket for 150mm tubes
122 02 00 03 1 **£44.90**



IRiS+ LED Bubble Tube

The wireless control capabilities with this Bubble Tube mean you can control it wirelessly with almost any mobile device. The IRiS+ LED Bubble Tube comes with an easy-to-use free downloadable app which features a comprehensive range of interactive options for users to experience. Features include a range of 8 colour options and 10 handy switch modes including touch, sound, vibration, rotation and relaxation, meaning the possibilities are endless for exciting and entertaining users across all abilities. The app is available from any App Store and is called Experia IRiS+.

This Bubble Tube also aids in development of cause and effect skills, along with colour recognition. It also helps calm users with the soothing colour display to create a relaxed sensory space.

Please Note: This Bubble Tube is 150mm in diameter.

IRiS+ LED Bubble Tube 1m	
122 16 00 02 1	£1,630.00
IRiS+ LED Bubble Tube 1.5m	
122 16 00 02 2	£1,650.00
IRiS+ LED Bubble Tube 2m	
122 16 00 02 3	£1,670.00
Bubble Tube Bracket for 150mm tubes	
122 02 00 03 1	£44.99

Gigantic LED Bubble Tubes

Need a Bubble Tube that's bigger? No problem. Our standard tube diameter is 150mm but these 200mm tubes help create more of a feature in a sensory room, especially when used alongside one or two standard sized bubble tubes.

Dimensions: IRiS Gigantic LED Bubble Tube 2m x 200mm Dia

122 01 00 13 5	£1,539.00
IRiS Gigantic LED Bubble Tube 1.5m x 200mm Dia	
122 01 00 13 6	£1,484.00
IRiS Gigantic LED Bubble Tube 1m x 200mm Dia	
122 01 00 13 7	£1,429.00
Bubble Tube Bracket for 200mm Dia	
122 02 00 03 2	£54.99

IRiS LED Bubble Wall

Nothing can beat this Bubble Wall; it's the best on the market! A great benefit of this product is that it's part of the state-of-the-art wireless IRiS range, so it can be used in conjunction with a whole range of IRiS products.

The IRiS LED Bubble Wall works brilliantly to aid in key life skill development using the range of wireless switches available to the user.

This Bubble Wall works well to aid in development of cause and effect skills, along with colour recognition.

This Bubble Wall features a calming mode, which allows the colours to scroll softly to promote a relaxing environment.

The IRiS LED Bubble Wall can also be controlled by any IRiS Talker (switch), see page 41.

IRiS LED Bubble Wall Inc Fill Kit	£1,899.00
122 01 00 47	

IRiS+ LED Bubble Wall

The wireless control capabilities with this Bubble Wall mean you can control it wirelessly with almost any mobile device. The IRiS+ LED Bubble Wall comes with an easy-to-use free downloadable app which features a comprehensive range of interactive options for users to experience. Features include a range of 8 colour options and 10 switch modes including touch, sound, vibration, rotation and relaxation, meaning the possibilities are endless for exciting and entertaining users across all abilities. The app is available from any App Store and is called Experia IRiS+.

This Bubble Tube also aids in development of cause and effect skills, along with colour recognition. It also helps calm users with the soothing colour display to create a relaxed sensory space.

IRiS+ LED Bubble Wall	£2,199.00
122 16 00 10	

IRiS Bundles

Skills	IRiS Soundboard Bundle	IRiS Bubble Tube Bundle	IRiS Bubble Wall Bundle	IRiS Fibre Optic Bundle
Tactile	✓	✓	✓	✓
Cause and Effect	✓	✓	✓	✓
Colour Recognition	✓	✓	✓	✓
Switching Skills				
Dexterity	✓	✓	✓	✓
Vocalisation				
Gross Motor Skills	✓	✓	✓	✓
Fine Motor Skills				
Matching Skills	✓			
Social Skills	✓			
Balance Skills				
Group Participation	✓			

- All products are powered using mains voltage unless otherwise stated.
- 3 Year warranty on all products, giving you peace of mind.

IRiS Soundboard Bundle

Wirelessly interact with the IRiS Soundboard Bundle. This Bundle is ideal to aid in development of sound and language skills with groups or individuals of all abilities. The IRiS Qube features clear sleeves on each side, which allows you to insert an item or image of your choice that corresponds with one of 8 images displayed on the Soundboard which illuminate and play. This bundle is great to develop matching skills. Just roll the Qube to hear the corresponding sound played by the Soundboard. The Soundboard includes 64 pre-recorded sounds, musical clips and noises, with the option to specifically tailor another 16 sounds, making it unique to your requirements.

Dimensions: IRiS Soundboard - 1380mm W x 130mm D x 820mm H.
IRiS Qube - 200mm Square

Please Note: The IRiS Qube is powered by a 9v PP3 replaceable battery (supplied). Also, while the Soundboard is portable, we recommend wall mounting as all fittings are included.

IRiS Soundboard and Qube Bundle
122 01 00 70 **£1429.00**



IRiS LED Bubble Tube Bundle

Introduce the state-of-the-art wireless IRiS range for the best interactive learning with this brilliant bundle. This bundle comes complete with large 1.5mm IRiS Bubble Tube, IRiS Recordable Speaker and IRiS 200m Qube, which operates from a distance of 30m – fantastic in larger rooms. To develop colour recognition and cause and effect skills, users can roll the Qube and whichever colour is displayed on the top, is then shown within the 150mm wide Bubble Tube. The colour is then announced by the Recordable Speaker. The Speaker includes 64 pre-recorded sounds, musical clips and noises, with the option to specifically tailor another 16 sounds, making it unique to your requirements.

Please Note: The Recordable Speaker and Bubble Tube are mains powered, which is transformed to a safer low voltage, while the Qube uses a 9V PP3 Battery which is supplied.

Dimensions: The Bubble Tube is 150mm in diameter and 1.5m height.

IRiS LED Bubble Tube and Qube Bundle
122 01 00 81 **£1,649.00**
Bubble Tube Bracket for 150mm tubes
122 02 00 03 1 **£44.99**

IRiS LED Bubble Wall Bundle

The perfect interactive bundle to aid learning and development. This features a super soft multi-coloured IRiS Qube that when rolled up to a distance of 30m, the colour that's displayed on top of the Qube, is then displayed on the Bubble Wall and also announced on the Recordable Speaker. There's also the option to record additional sounds on the speaker to make the experience more unique and better tailored to the user. It's a fun interactive bundle that users will love to get involved in. Please Note: This bundle is compatible with any IRiS Talker for added flexibility. The IRiS Qube is powered by a 9v PP3 replaceable battery (supplied) and the IRiS Recordable Speaker and LED Bubble Wall are powered using mains voltage which is transformed to a safer low voltage.

Dimensions: IRiS Recordable Speaker - 140mm W x 220mm D x 55mm H.
IRiS Qube - 200mm x 200mm x 200mm.

IRiS LED Bubble Wall & Qube Bundle
122 15 00 22 **£2,799.00**

IRiS LED Fibre Optic Qube Bundle

Utilise the wireless capabilities of this bundle and control the fibre optics with the IRiS Qube, just roll the Qube for a colour to appear. This product comes complete with a battery powered IRiS Qube and works with any IRiS talking device (Other IRiS products sold separately) This also comes in a calming mode as standard which gently scrolls through eight vibrant colours to relax the senses.

Please Note: LED lightsource is included and comes with 150 standard 2000mm strands. It is mains powered, transformed to a safer low voltage, while the Qube uses a 9V PP3 Battery which is supplied.

IRiS LED Fibre Optic Qube Bundle
122 15 00 12 **£1162.00**

Case Study Aspire School

Aspire School in Sittingbourne, Kent, is a special free school that caters for children aged 4 to 11 years.

Opening its doors in 2020, the school has welcomed 32 pupils so far, with plans to extend to 160 children over the next four years.

The curriculum reflects the full range of pupils' needs and is tailored to their individual starting points. When it is running at full capacity, there will be 21 classes with two to three teaching assistants.

Run by Grove Park Academies Trust, Aspire School specifically caters for children with Autistic Spectrum Disorder (ASD) and other severe speech and language difficulties.

Neil explained that the name of the school was chosen because of the school's ethos – they believe that all children can aspire to great things, despite any barriers they may face.

The school was designed by architect Bond Bryan and built by BAM – the construction company has worked on more than 100 major projects in Kent since 1877. It recently completed four special educational needs schools in the county.



Aspire School came into existence because of the vision of parents in the local area, as long ago as 2013. There was an increased need in the area for a special school, and it was designed based on the specific requirements of the children who were to attend.

The school's aim was to install a sensory room that offered both multi-sensory experiences, as well as a starting point for learning. Because of this, an immersive space was the perfect option.

Immersive Reality was invited to visit the school to discuss their wants and desires for the space. We worked closely with Aspire School to create the perfect sensory space for pupils. Installed by ourselves in March 2021, the school's Immersive Room has been an amazing success, and is loved by teachers and pupils alike.

One of our team members stated, "Neil knew exactly what he wanted to achieve from the room. He didn't want a sensory room, he wanted something that could be a sensory room, but so much more!" Neil's clear vision of the space gave us the perfect starting point for designing the room specifically for the school's needs.

Despite the room being the perfect shape for an immersive space, it does have an obstruction which would cause a problem for many companies – a door! We overcame this obstruction by working closely with the school and making some

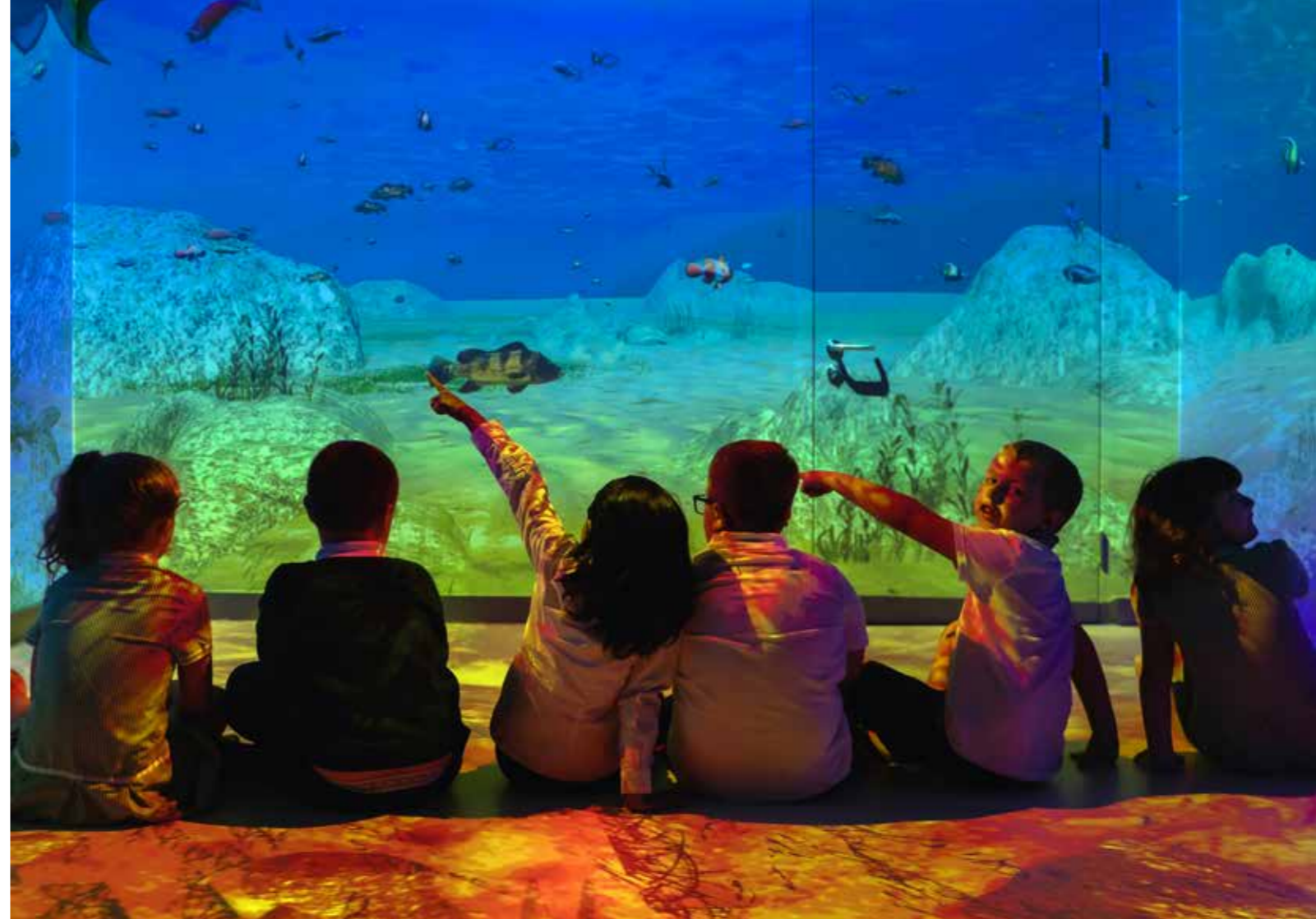

"It was one of the best decisions we have made!"

Neil Dipple, Headteacher at Aspire School.

small adjustments. We also changed the wall colour, floor covering, ceiling colour, and provided an electrical plan to local contractors. This ensured the room would be the perfect space, despite having obstruction issues to begin with.

Once the room was installed, we worked closely with Aspire School to create specific content tailored for them. Neil stated, "It is used for many different purposes." The uses of the room are extensive, from being a calm environment for pupils to relax, to introducing them to new topics and experiences that they may have never encountered before.

Pupils are captivated by many different aspects of the room. Neil explained that "many different scenes are popular with different groups of children. Some children like the cause and effect scenes, such as the fish or firework interactive scenes. Some of our children prefer the free-roaming environments that they can explore."

"I would thoroughly recommend it" stated Neil, who explained that the space has increased pupil engagement, as well as made the children extremely happy! The diversity of our content means that there is

something for every child to enjoy and take part in.

An Immersive Space is a valuable teaching tool for special education that allows pupils to experience learning in new ways, while fully supporting the curriculum. Its multi-sensory experiences also make the space perfect for relaxation and re-regulation.

For more information on the immersive space, check out the school's website here!

If your pupils deserve a room like this, contact us on 0161 731 0010 or email us at info@immersivereality.co.uk. We'd love to hear from you!



Immersive Reality Spaces



We are delighted to bring you the very latest in Immersive technology from Immersive Reality.

An Immersive Reality space is a special place where anything can be accomplished - learning, simulation, relaxation, infact almost anything.

It's a space where the user is surrounded by high quality projection. With the addition of light, sound, aroma, wind, vibration, fog and even snow, we create a rich, exciting environment in which to encounter new enthralling experiences.

It utilises HD quality projectors to project onto multiple walls and the floor to produce a stunning visual experience. The user can control all aspects within the space in a variety of ways including touch and movement control, gesture control, wireless Xbox controller and the incredible Xbox Adaptive Controller created by Microsoft. The touch and movement control allows intuitive interaction often without any prompting required, the Xbox wireless controller brings a familiarity to a huge range of users and the Xbox Adaptive Controller allows those with limited movement or dexterity the opportunity to control the space. We use all these enabling switches and more to ensure the space is available to all regardless of age or ability. And it's very easy for staff to use - just press a single button to select scenes.

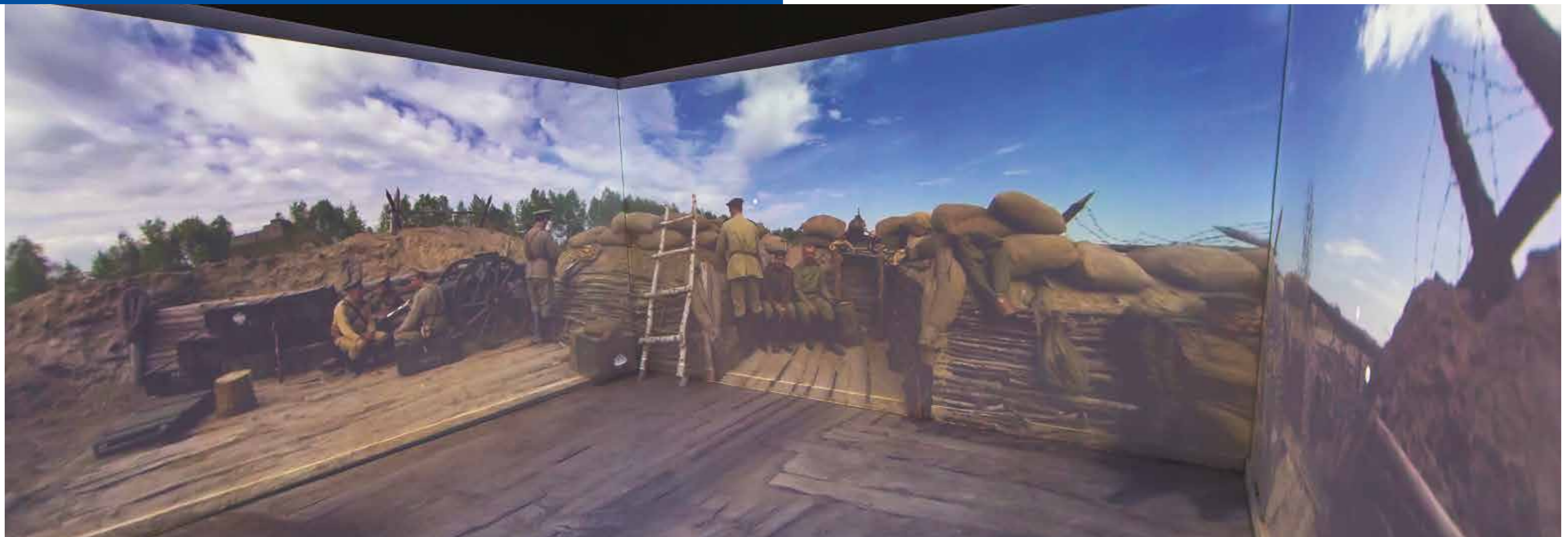

But what really makes our Immersive Reality space really special is the astonishing content that we have created!

We use stunning 360 video and images, high resolution images, game quality interaction and computer generated virtual reality scenes to produce content that inspires, educates, calms and excites people of all ages. Utilising the latest CGI, we create dynamic, interactive scenes that are as realistic as possible! The use of this technology creates exceptional content that extends user engagement and gives an unsurpassed experience. Take a trip through the galaxy to learn about the solar system, swim underwater and interact with fish, walk through a meadow and play with the butterflies, board an underground train and learn how to navigate through tunnels and up an escalator, we have content to suit all.

With over 400 scenes and growing, here is a brief list showing some of the content we have created:

- Paragliding
- Zip Slide
- Roller Coaster
- The Digestive System
- The Water Cycle
- Journey through the body
- British Countryside
- Arctic
- Serengeti
- Underwater
- Forest
- Snowstorm
- Underground Station
- Supermarket
- Airplane

Immersive Reality spaces are accessible to all, regardless of ability using a variety of innovative wireless solutions:

- Multi-touch Walls
- Multi-touch Floor
- Gesture Control
- Xbox Controller
- Xbox Adaptive Controller
- Wireless Switches

The space can be used for many purposes including:

- Development of Lifeskills
- Education
- Experiences
- Exploration
- Sport
- Fun

Visit www.experia.co.uk/sensory-rooms/immersive-environments for further details.

If you think an Immersive Reality space would be beneficial for your establishment then contact us now for a free design and quotation on 0800 612 6077 or email: info@experia.co.uk



Interactive Floor



Our Interactive Floor System offers floor projection that responds to body movement when it is detected by the state-of-the-art overhead camera.

Anyone can interact with the system, even those with very limited movement, to alter many aspects of their immediate environment, making the product fully inclusive.



Interactive Floor



Any image, video and audio file can be added to the many effects available to build up a structured sequence specifically targeted at each learner. Teachers or therapists can design a programme around a pupil's specific needs and save it to the hard drive to use at a later date. Full training on the system is provided anywhere within mainland UK.

With sturdy lockable wheels, the Floor System can easily be moved from room to room and the integral camera head lowers for easy access through doorways to make movement of the product simple.

A range of stimulating interactive and colourful games that come with the Floor System include 'Splat the Insects', 'Scatter the Stars' and 'Whack-a-Mole'. The Floor System can project images onto the floor or ceiling making it ideal for those standing, using a wheelchair, lying on the floor or in bed, or there is a fixed option available where space is at a premium.

SENse Flex

A mobile, portable interactive Sensory System - Electronically Height adjustable. This can do a range of interactive projection sizes from 1.35m W x 1.03m H through to 2.2m H x 2.9m W. It can also project onto tables, as well as floor projection from the same unit.

The Flex combines new technology with simple design to provide an affordable, fully portable system for use in schools or at home. The Flex creates colourful, engaging floor projections which respond and interact to body movement. The Flex creates a complete sensory zone by allowing even those with limited movement to alter many aspects of their immediate environment. The Flex is electronically height adjustable allowing the projected surface to work equally well on the floor, table or bed.

Any image, video and audio file can be added to the many effects available enabling teachers or parents to design specific programmes for individual users.

The Flex is simple to operate. A full training manual and telephone support is provided as part of the package. The Flex software and high brightness projector create multiple themes and images which are combined with in-built speakers and an amplifier for excellent audio effects. A range of stimulating interactive and colourful themes includes 'Splat the Balloons', 'Scatter the Flowers' and an interactive fishpond. With the addition of electronic height adjustment, the projected image is responsive on all surfaces offering total flexibility and is ideal for any school or home environment.

SENse Flex+

Enjoy all the features of the SENse Flex but with the added benefit of Gesture wall projection.

This is:

Height adjustable at the touch of a button, fully mobile with castors.

Variable Projection size from 1.35m W x 1.03m H to 3.1m W x 2.24m H.

Can easily be used for table, wall, or floor projection all from one unit.

The SENse Flex+ has an in-built gesture camera, simply lay the SENse Flex+ onto its back and it will project an image onto the wall and will allow you to interact with the theme on the wall via gesture. Within the software, the ability to use the webcam will allow you to see yourself while interacting with the projection. The SENse Flex+ really is the most versatile projection unit in the range; choose between floor, table, or wall, all from one unit!

If you would like us to install a fixed system, please contact us for an installation cost.

Interactive Floor System - Flex

122 92 00 10

£6,245.00

Interactive Floor System - Flex+

122 92 00 09

£8,245.00

Interactive Floor System - Fixed

122 92 00 02

£7,695.00

Wall Panels



Built to the highest standard, Experia's wall panel range offers a multitude of colours and patterns ideal for creating both a calming and interactive environment while encouraging key life skill development. Brilliantly effective additions to any room, sensory wall panels produce mesmerizing and striking effects that enhance the sensory experience.



Sound Board

Customisable sounds and images at the touch of a button. The Soundboard can aid in development of sound and language skills with groups or individuals with sound and light being the reward.

This comprises eight frames with themed images which illuminate and play one of eight pre-recorded sounds when the button below it is pressed.

The unit has 64 pre-recorded audio samples and the facility to add another sixteen sounds of your own, making it easy to personalise the experience individually for each user/group of users.

There is an IRiS version available in this product which is controlled by any IRiS Wireless Talker – see page 41 for the IRiS range. This allows all users with varied abilities to develop their own specific skills.

Dimensions: Each unit is 1380mm W x 130mm D x 820mm H.

Soundboard 122 48 00 95	£989.00
IRiS Soundboard 122 01 00 69	£1,154.00
IRiS Soundboard & Qube Bundle 122 01 00 70	£1,472.00

Skills	Sound Board	Sound Wall	LED Infinity Tunnel	LED Star Tunnel	LED 3 Shape Infinity Tunnel	Interactive Hand Carpet	Interactive Touchwall
Sound	✓	✓					✓
Touch	✓	✓				✓	✓
Movement	✓	✓	✓	✓	✓	✓	✓
Light	✓	✓	✓	✓	✓	✓	✓
Texture						✓	
Colour	✓	✓	✓	✓	✓	✓	✓
Hand to eye coordination	✓	✓				✓	✓
Tracking Skills							✓
Cause and Effect	✓	✓				✓	✓
Vocal Skills	✓	✓				✓	✓
Colour Recognition			✓	✓	✓	✓	✓
Shape Recognition	✓						✓
Anticipation							✓
Superactive Version available			✓	✓	✓		
IRiS Version available	✓		✓	✓	✓		

- All products are powered using mains voltage unless otherwise stated.
- All wireless controllers feature Qi charging so there's no battery to change.
- Housed in a tough, easy to clean enclosure.
- 3 Year warranty on all wall panels, giving you peace of mind.
- All Wall Panels should be wall mounted (fittings included) unless otherwise stated.



Sound Wall

Develop cause and effect skills with this fun way to create sounds.

Users can simply touch or place their hand in front of one of the eight colour-coded hands to generate different sounds and effects.

The Sound Wall is perfect for those with limited mobility as the unit uses the latest technology to feel or sense hand movement and reward with sound.

The unit has 64 pre-recorded audio samples and the facility to add another sixteen sounds of your own, making it easy to personalise the experience individually for each user/group of users.

Please Note: The Sound Wall has a two integral speakers and an amplifier for crisp sound and measures 1200mm W x 90mm D x 145mm H.

Sound Wall 122 07 00 01	£1,869.00
--------------------------------	------------------



LED Infinity Tunnel

Marvel at the seemingly never ending lights with the LED Infinity Tunnel. This Tunnel creates an amazing illusion of lights that slowly change colour and continue into the distance forever making it a great favourite with all ages and abilities. There is a Superactive version of this product available that comes with a wireless controller allowing the user to switch between eight colours. An IRiS version is also available which is controlled by any IRiS wireless Talker- see page 41 for the IRiS range.

Please Note: All of the units are compact and 820mm W x 650mm D x 80mm H.

Calming LED Infinity Tunnel 122 07 00 10	£769.00
Superactive LED Infinity Tunnel 122 56 00 02	£879.00
IRiS LED Infinity Tunnel 122 01 00 57	£1,099.00

LED Infinity Tunnel - 3 Shapes

Create a stunning focal point in any sensory space that promotes a calm and relaxed atmosphere. Featuring a super wide set of 3 LED Tunnels in one displaying a circle, square and triangle, making it perfect for both individual and group use. There is a Superactive version of this product available that comes with a wireless controller allowing the user to switch between eight colours. An IRiS version is also available which is controlled by any IRiS wireless Talker - see page 41 for the IRiS range.

Dimensions: All of the units are 1620mm W x 540mm x H x 120mm D.

Calming LED Infinity Tunnel - 3 122 07 00 19	£1,199.00
Superactive LED Infinity Tunnel - 3 122 56 00 18	£1,310.00
IRiS LED Infinity Tunnel - 3 122 01 00 65	£1,539.00

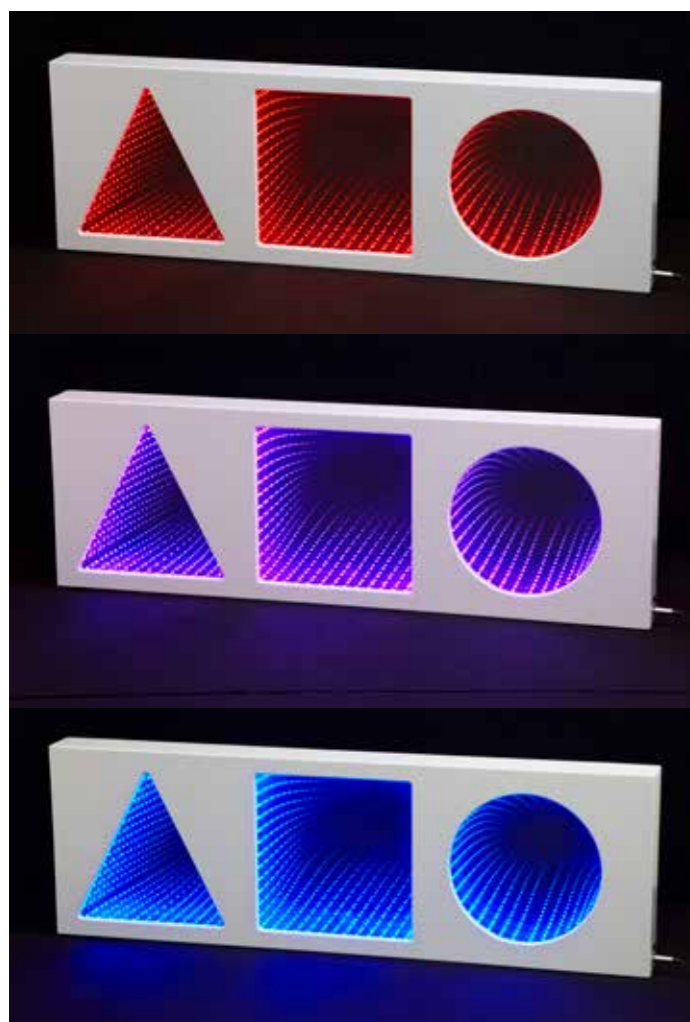

Interactive LED Fibre Optic Hand Carpet

A touch sensitive carpet for users to interact with. With this product, users can touch the smooth hand shaped panels for an immediate colour change effect of the stunning fibre optic carpet behind. Users can enjoy the differing textures here with the smooth acrylic hands offering a sharp contrast to the rugged carpet. The Interactive LED Fibre Optic Hand Carpet works brilliantly at developing gross motor and also cause and effect skills.

Please Note: LED lightsource comes with approx 248 strands with 4 colour modes. Hand carpet measures at 1450mm H x 1200mm W x 90mm D.

Interactive LED Hand Carpet 122 03 00 30	£1,759.00
--	------------------

Musical Touch Wall

The Musical Touch wall is a unique, state-of-the-art developmental tool, jam packed with 11 carefully created modes specifically designed to develop a range of life-skills, through visual stimulation in response to touch. Ideal for use within a school setting, hospital, day care centre, children's nursery or assessment centre, this unit creates a visually stimulating experience that appeals to users of all ages and abilities. It's also really easy to use. Just select your own combination of mode (shape), speed, sensitivity and fade using the control panel and create lots of different beautiful effects and challenges as the user moves their hand across the front of the unit.

Dimensions: The unit is 820mm H x 650mm W x 80mm D. Two versions are available, with and without sound.

Touch Wall 122 48 00 80	£2,084.50
Musical Touch Wall 122 48 00 81	£2,475.00



Wall Panels - Sound activated



Our range of sound activated wall panels aid in development of a variety of key life skills.

They encourage the users to make a sound to activate any of these products. Just clap your hands, speak, tap a drum or even sing to develop a wide range of life skills in a fun and entertaining way.

All products come complete with an external microphone unless otherwise stated.

Skills	Interactive LED Fanlite	Deluxe LED Fanlite	Interactive LED Ladderlite	Deluxe LED Ladderlite	LED Sound to Panel Light	Deluxe LED Infinity Tunnel	Deluxe Bubble Wall	Deluxe Soundstar
Sound	✓	✓	✓	✓	✓	✓	✓	✓
Touch								
Movement	✓	✓	✓	✓	✓	✓	✓	✓
Light	✓	✓	✓	✓	✓	✓	✓	✓
Texture								
Colour	✓	✓	✓	✓	✓	✓	✓	✓
Vocalisation Skills	✓	✓	✓	✓	✓	✓	✓	✓
Tracking Skills	✓	✓	✓	✓	✓		✓	✓
Cause and Effect	✓	✓	✓	✓	✓	✓	✓	✓
Colour Recognition	✓	✓	✓	✓	✓	✓	✓	✓
Communication Skills	✓	✓	✓	✓	✓	✓	✓	✓



Interactive LED Fanlite

Encourage vocal skills with this compact Interactive LED Fanlite.

This multi-coloured Fanlite has bright LED's which are activated by sound; ideal for developing vocalisation, cause and effect, as well as tracking skills in a fun and interactive way.

It's simple to use; just speak, shout or clap into the internal microphone or the versatile external microphone (included) and users are rewarded with a beautiful Fanlite colour display.

This unit features three automatic and five sound activated modes which have speed and sensitivity settings that can be altered to best suit the user.

Dimensions: The unit is 1430mm W x 850mm H x 100mm D. This product has a 4m cable, giving increased flexibility.

Interactive LED Fanlite

122 48 00 91

£879.00

Deluxe LED Fanlite

The next generation of our LED Fanlite is this Deluxe version; a fantastic product specially designed to develop vocalisation and tracking skills.

The product helps excite and encourage the user by displaying an attractive horizontal visual representation of sounds as they're inputted via the external microphone (supplied) which has a 4m cable giving increased flexibility. Packed full of 26 engaging and differing modes to suit a wide range of users, the Deluxe LED Fanlite really does offer something for everyone, regardless of age or ability.

Dimensions: The unit is 1430mm W x 850mm H x 100mm D.

Deluxe LED Fanlite

122 48 00 66

£1,895.00

LED Sound to Light Panel

Create an interactive sound, colour and light experience for vocal training.

The LED Sound to Light Panel is a fun aid to learning as users can watch as the colours react across the screen to sounds. This is ideal for developing vocalisation, cause and effect, as well as tracking skills in a fun and interactive way.

Users are rewarded when they speak, shout or clap into the internal microphone or the versatile external microphone (included) which has a 4m cable offering increased flexibility.

This product features three automatic and five sound activated modes which have speed and sensitivity settings.

Dimensions: The unit is 1430mm W x 850mm H x 100mm D.

LED Sound to Light Panel

122 07 00 07

£769.00



Deluxe LED Ladderlite

This is a fantastic product to develop vocalisation skills. It helps excite and encourage the user by displaying an attractive vertical visual representation of sounds as they're inputted via the external microphone (supplied) which has a 4m cable offering increased flexibility. Packed full of 26 engaging and differing modes to suit a wide range of users, the Deluxe LED Ladderlite really does offer something for everyone, regardless of age or ability. This is a super tall unit at 1.6m high, which reacts to sounds and vocals as the colours spread up the unit as the sound gets louder. Users are rewarded when they speak, shout or clap into the internal microphone or the versatile external microphone (included) which has a 4m cable offering increased flexibility.

Dimensions: The unit is 520mm W x 135mm D x 1600mm H.

Deluxe LED Ladderlite
122 48 00 67 **£1,895.00**

Interactive LED Ladderlite

A visually striking way for group or individual vocal training. The Interactive LED Ladderlite is super tall at 1.6m high. It reacts to sounds and vocals as the colours light up the unit as the sound gets louder. Users are rewarded when they speak, shout or clap into the internal microphone or the versatile external microphone (included) which has a 4m cable offering increased flexibility. This unit features three automatic and five sound activated modes which have speed and sensitivity settings that can be altered to best suit the user.

Dimensions: The unit is 520mm W x 135mm D x 1600mm H.

Interactive LED Ladderlite
122 48 00 92 **£879.00**

Deluxe LED Infinity Tunnel

Create the illusion of a never ending light display with this amazing product. The Deluxe LED Infinity Tunnel is a fantastic product to develop vocalisation skills. It helps excite and encourage the user by displaying a beautiful visual representation of sounds as they're inputted via the external microphone (supplied) which has a 4m cable giving increased flexibility. Packed full of 26 engaging and differing modes to suit a wide range of users, the Deluxe LED Ladderlite really does offer something for everyone, regardless of age or ability.

Dimensions: The unit is 520mm W x 135mm D x 580mm H.

Deluxe LED Infinity Tunnel
122 48 00 68 **£1,395.00**



Deluxe LED Bubble Wall

A truly spectacular sight featuring bright LED lights on either side of the Deluxe LED Bubble Wall creating the illusion of two Bubble Walls in one! This is a brand new product which encourages the development of vocalisation skills in users in an interesting, albeit unusual way. Aesthetically appealing, the Deluxe LED Bubble Wall features 26 different modes to both excite and challenge the user. Users can also create stunning colour variations with the advanced RGBW LEDs and make use of the external microphone which comes with this product.

Dimensions: The unit is 520mm W x 135mm D x 1600mm H.

Deluxe LED Infinity Tunnel
122 48 00 69 **£2,495.00**

Deluxe LED Soundstar

The Deluxe LED Soundstar is an impressive new product that will look brilliant in any sensory room. Well utilised in special schools, hospitals and hospices, this unit uses the latest in LED technology to create a superb visual effect. It's the ideal product for developing a range of key life skills and helps excite and encourage the user by displaying an attractive circular visual representation of sounds as they're inputted via the external microphone (supplied), which has a 4m cable offering increased flexibility. Packed full of 26 engaging and differing modes to suit a wide range of users, the Deluxe LED Soundstar really does offer something for everyone, regardless of age or ability.

Dimensions: Each unit is 1380mm H x 130mm D x 820mm W.

Deluxe LED Soundstar
122 48 00 70 **£2,295.00**

Tactile



With our attractive range of tactile panels, you can take the user on a colourful sensory experience that encourages them to reach out and touch the visually stunning effects these products create.



Tactile Panel

The use of a Tactile panel brings an attractive, bright and engaging sensory experience for the user to enjoy. They are encouraged to follow around and touch an artistic shape which moves around the panel; this is also an excellent way of assessing what a user likes and dislikes.

Tactile panels come in a variety of textures including soft, hard, smooth, rough, cool, warm. They're made from Russian Birch, meaning they are strong, durable and appeal to those across all ages and abilities.

As well as the above, Tactile panels are also available in a range of materials including metal, plastic, wood, carpet, mirror.

This amazing versatility allows the panels to be tailored specifically to each user to make their sensory experience unique to them.

Please Note: Tactile panels are available in either circular or square shapes. They can fit directly onto a wall and have a 1.2 metre diameter.

Tactile Panel - Circular Standard

122 37 00 01

£925.00

Tactile Panel - Square Standard

122 37 00 02

£925.00

UV Tactile Panel

Designed with visually impaired users in mind, the UV Tactile panel creates an amazing visual display which works best in a darkened room.

Featuring bright UV light which stands out among the darkness, the shapes burst into life and create a truly magical sensory experience.

The UV Tactile panel displays an artistic shape which meanders around the panel and encourages a user to reach out and touch it and follow it around.

UV Tactile panels come in a variety of textures including soft, hard, smooth, rough, cool, warm. They're made from Russian Birch, meaning they are strong, durable and appeal to those across all ages and abilities.

As well as the above, UV Tactile panels are also available in a range of materials including metal, plastic, wood, carpet, mirror.

This amazing versatility allows the panels to be tailored specifically to each user to make their sensory experience unique to them.

Please Note: Tactile panels are available in either circular or square shapes. They can fit directly onto a wall and have a 1.2 metre diameter.

UV Tactile Panel - Circular Standard

122 37 00 03

£995.00

UV Tactile Panel - Square Standard

122 37 00 04

£995.00

Sensory Effects



Take a look at our Sensory Effect products, which immediately elevates the sensory experience for users and adds an extra dimension to any sensory room.

All products are mains powered unless otherwise stated. Wall brackets are available to purchase separately for these products.



Fog Machine

The Fog machine is an excellent sensory tool which creates an amazing 3D atmosphere. When used with any focused light product, users can enjoy a stunning display featuring beams of light which are streamed all around them, allowing the user to reach out and touch them. This is a true sensory experience that captures the imagination and creates a calming, ethereal atmosphere. The Fog unit uses water based fog fluid, which is available separately and creates a totally harmless fog. This means it is suitable for even those with respiratory needs and can be enjoyed by everyone.

- Fog Machine** 122 48 00 22 **£298.00**
- 5L Fog Fluid** 122 33 00 07 **£21.99**
- Black Wall Bracket** 122 33 00 22 B **£26.39**
- White Wall Bracket** 122 33 00 22 W **£26.39**



Snow Machine

A Beautiful Winter Wonderland awaits you with this easy to use Snow Machine. A real treat for the senses, our Snow Machine shoots flurries of snow into the air, creating a wonderful sensory experience that's both fun to watch and feel as the snow gently lands on the user's skin. Just fill the reservoir with the snow fluid (sold separately) and may the snow day begin! A handy wireless remote makes it even easier to use as you're able to change settings at the click of a button.

- Snow Machine** 122 48 00 21 **£289.00**
- Snow Fluid** 122 33 00 08 **£27.49**
- Black Wall Bracket** 122 33 00 22 B **£26.39**
- White Wall Bracket** 122 33 00 22 W **£26.39**



Bubble Machine

Everyone loves bubbles, especially when they're floating all around just waiting to be popped! With our Bubble Machine, users can enjoy hundreds of mesmerising bubbles as they're automatically pushed into the air by the powerful machine. This creates a totally immersive sensory experience featuring bubbles of all sizes floating in all directions for the user to enjoy.

- Bubble Machine** 122 48 00 15 **£235.00**
- Bubble Fluid** 122 33 00 13 **£27.49**
- Black Wall Bracket** 122 33 00 22 B **£26.39**
- White Wall Bracket** 122 33 00 22 W **£26.39**



Baby Bubble Machine

A miniature version of the Bubble machine, the Baby Bubble Machine works on an automatic setting when switched on and shoots flurries of bubbles into the air for users to enjoy. Just add the bubble fluid and watch the bubbles as they float around the room serenely.

Important Details: Bubble fluid is provided with this machine. Machine is powered by 2 X AA batteries (not included).

- Baby Bubble Machine** 122 48 00 48 **£19.95**

Sensory Lighting



Lighting in a sensory space is hugely important, as it helps transform a space into a magical atmosphere that encourages imagination and creates a calming, relaxed environment for users to enjoy.

Lighting can be used when storytelling or to help theme a sensory room, and it also helps bring stories to life through visually appealing light effects.

The use of lighting also aids in teaching colour recognition to both adults and children with sensory needs.

All products are mains powered transformed to a safer low voltage unless otherwise stated.



Mini LED Bubble Tube

It may be small, but it really packs a punch when it comes to elevating your sensory environment. The Mini LED Bubble Tube is the ideal solution when space is minimal. The smallest bubble tube in our range, this one is jam packed with super bright LED technology.

The Mini LED Bubble Tube takes the user on a calming sensory journey as it gently scrolls through eight vibrant colour variations that illuminate up the 100mm wide bubble tube.

A benefit is that it's super lightweight at only 1.9kg, which allows it to be lifted easily into place.

Dimensions: The Mini LED Bubble Tube is 500mm H with a 75mm diameter base.

Mini LED Bubble Tube 500mm
122 02 00 33 **£399.00**



LED Pinspot and Mirror Ball Set

Create a sparkling disco ball effect with the LED Pinspot and Mirror Ball Set.

The spectacular colour changing LED Pinspot shines onto the mirror ball to create the most stunning visual display. This set includes a 300mm mirror ball complete with a 150mm chain which is connected to a rotating motor, as well as a powerful LED spotlight that automatically changes colour.

Please Note: Full wall mounting kit is provided and both aspects of this set come complete with a fixed mains lead. No maintenance is required for this product.

LED Pinspot and Mirror Ball Set
122 48 00 11 **£178.99**



LED Pinspot - White

A Pin sharp beam of light is emitted by the LED Pinspot. Imagine shining this on a mirror ball, watching as the beam of light shoots off in all directions creating a sparkly disco room. The LED Pinspot works great to highlight particular areas within a room and requires absolutely no maintenance, so ease of use is a plus!

White Pinspot 122 48 00 24 **£109.99**



LED Pinspot - RGBW

Much like the original, this LED Pinspot changes colour as it emits a bright spotlight.

Create a multi colour changing sensory space with this Pinspot as the colours switch automatically, bathing the room in beautiful hues of Red, Green & Blue. This Pinspot also requires absolutely no maintenance, meaning it's totally fuss free.

Please Note: The LED Pinspot comes complete with a fixed mains lead.

LED Pinspot - RGB 122 48 00 26 **£124.99**



LED Ripple Light - RGBW

A Rippling water effect is all you'll need to calm the senses. The LED Ripple Light creates a water-like ripple effect which changes colours automatically and helps create a calming, relaxed environment for the user. This requires absolutely no maintenance, so is totally fuss free.

Please Note: The LED Ripple Light comes complete with a fixed mains lead.

LED Ripple Light 122 48 00 27 **£109.99**



Mirror Ball

Our Mirror Ball expertly reflects light in all directions to create the most magical, twinkling sensory space. The Mirror Ball is made out of a lightweight material and totally covered with polished mirror glass facets. It's available in three sizes so you can choose the one which best suits your sensory room. For ease of fitting, a full ceiling fixing kit is provided with the Mirror Ball, so you can just set it up and watch it sparkle.

Mirror Ball (200mm)	122 48 00 02 2	£54.00
Mirror Ball (300mm)	122 48 00 02 3	£70.00
Mirror Ball (400mm)	122 48 00 02 4	£135.00

Mirror Ball Motor

This is a handy replacement which can be used with any mirror ball.

The mains operated motor can easily rotate a mirror ball of up to 400mm in diameter. The Battery-operated motor can easily rotate a mirror ball of up to 200mm in diameter. Please check which it is you require before purchasing to ensure you receive the correct motor.

Mirror Ball Motor (Mains powered)	122 48 00 04 1	£27.49
Mirror Ball Motor (Battery powered)	122 48 00 04 2	£15.39

LED Mirror Ball Motor

Why not opt for a colourful LED Mirror Ball motor to light up your mirror ball?

This works with mirror balls up to 200mm in diameter and creates a visually stunning light effect as bright LED's shine down directly onto the mirror ball for an eye-catching mirror effect on the ceiling.

Please Note: The Mirror ball is sold separately and a full ceiling fixing kit is provided. The LED Mirror Ball Motor is powered by three AA batteries (not included).

LED Mirror Ball Motor	122 48 00 97	£16.49
------------------------------	--------------	--------



Calming LED Light Spreader

Just as the name suggests, the LED Light Spreader floods your space with beautiful bright colours and creates a calming sensory environment for the user to enjoy. Watch as the Light Spreader gently moves through eight vibrant colours to bathe the room in bright, relaxing light. Using the very latest LED technology, the Light Spreader is much more efficient and can either be wall or ceiling mounted.

Please Note: The Wall bracket is sold separately.

Calming LED Light Spreader	122 48 00 18	£384.00
Black Wall Bracket	122 33 00 22 B	£26.39
White Wall Bracket	122 33 00 22 W	£26.39

Superactive LED Light Spreader

Flood your sensory room with light and develop key life skills at the same time with the wireless controller that comes with the Superactive LED Light Spreader.

This product also features a slow setting, which enables the lights to change on a slower setting to promote a more relaxed, calming space.

Using the very latest LED technology, the Light Spreader is much more efficient and can either be wall or ceiling mounted.

Please Note: The wireless switch is battery operated and Qi enabled, so there's no battery replacement. The wall bracket is sold separately.

Superactive LED Light Spreader - 8 Way Switch	122 56 00 17	£769.00
Black Wall Bracket	122 33 00 22 B	£26.39
White Wall Bracket	122 33 00 22 W	£26.39

Calming LED Bundle

Bathe your sensory room in calming light in a range of coloured hues.

Using the simple interface, you can control the colour of the LED Light Spreader and set it to scroll gently through 8 vibrant colours for a relaxed ambience.

Using the very latest LED technology, the Light Spreader is much more efficient and can either be wall or ceiling mounted.

The Bundle Includes:

1 x User Interface, 1 X LED Driver, 4 X LED Spots

Calming Lighting Bundle - Recessed	122 48 00 38	£799.00
Calming Lighting Bundle - Surface	122 48 00 39	£1099.00

Sensory Ceilings



Too often forgotten about and undervalued, the ceiling is a great place to utilise sensory equipment. Many users often lay on their back on a bed or bean bag to get comfortable, and so naturally tend to look upwards towards the ceiling.

Here at Experia, we have a wide range of sensory ceilings to suit the size and shape of your room. These include our Calming, Superactive and IRiS products; this means we really do have a sensory ceiling to suit everyone.

All Sensory Ceilings are created using the latest LED technology and are operated on mains voltage transformed to safer lower voltage.

- All products are powered using mains voltage transformed to safer low voltage unless otherwise stated.
- All wireless controllers feature Qi charging so there's no battery to change.
- 3 Year warranty on all products, giving you peace of mind.

Calming Sensory Ceiling

Gently scrolling between 8 vibrant colours, the Calming Sensory Ceiling works perfectly to help create a gentle, relaxing ambience in any sensory room. This is the ideal product to help relieve stress, anxiety and generally ease users into relaxation. The Calming Sensory Ceiling comes in a range of 6 diverse patterns and shapes to choose from.

Dimensions: Each Sensory Ceiling tile measures at 595mm x 595mm.

Ceiling Panels

Set of 2 - Calming	122 52 00 01	£549.00
Set of 4 - Calming	122 52 00 02	£1,076.00
Set of 6 - Calming	122 52 00 03	£1,603.00
Set of 8 - Calming	122 52 00 04	£2,130.00



Superactive Sensory Ceiling

Expand your wireless capabilities and control the colour of the Superactive Sensory Ceiling with the wireless controller provided (battery powered).

The Superactive Sensory Ceiling works brilliantly to aid the development of cause and effect skills. The wireless controller allows users to scroll between 8 diverse colours and also features a calming mode which gently scrolls through the vibrant colour variations. The Superactive Sensory Ceiling comes in a choice of 6 diverse patterns and shapes.

Dimensions: Each Sensory Ceiling tile measures at 595mm x 595mm.

Ceiling Panels

Set of 2 - Superactive	122 52 00 05	£1020.00
Set of 4 - Superactive	122 52 00 06	£1,649.00
Set of 6 - Superactive	122 52 00 07	£2,418.00
Set of 8 - Superactive	122 52 00 08	£3,298.00

IRiS Sensory Ceiling



Encourage users to control the colour of the sensory ceiling with the IRiS Colour Selector provided or alternatively any other IRiS talker from the IRiS range.

The IRiS Colour Selector lets users choose from 8 vibrant colours and the IRiS Sensory Ceiling also features a calming mode which gently scrolls through the vibrant colour variations. This comes in a range of 6 diverse patterns and shapes to choose from.

Dimensions: Each Sensory Ceiling tile measures at 595mm x 595mm.

Ceiling Panels

Set of 2 - IRiS	122 52 00 09	£769.00
Set of 4 - IRiS	122 52 00 10	£1,649.00
Set of 6 - IRiS	122 52 00 11	£2,418.00
Set of 8 - IRiS	122 52 00 12	£3,298.00

Fibre Optic Ceiling

Create a real visual treat for users using tiny fibre optics which illuminate this mirrored panel beautifully.

The Fibre Optic Ceiling creates the illusion of stunningly bright coloured stars that slowly change colour and seemingly continue on to infinity.

This is the ideal product to help relieve stress, anxiety and generally ease users into relaxation. The Fibre Optic Ceiling comes in a range of 6 diverse patterns and shapes to choose from.

A superactive version is also available with a wireless controller that allows the user to switch between a range of 8 colours. An IRiS version is available too; this is controlled by any IRiS Talker so is ideal for key life skills development.

Dimensions: Each Sensory Ceiling tile measures at 595mm x 595mm.

Fibre Optic Ceilings

Set of 4 - Calming	122 03 00 10	£659.00
Set of 4 - Superactive	122 03 00 10 1	£879.00
Set of 4 - IRiS	122 03 00 10 2	£1,099.00

Sensory Bundles



Our comprehensive Sensory Bundles have been designed for use by all ages and abilities, offering a fully inclusive user experience.

Here at Experia, we can provide the specific sensory equipment you require based on your individual needs, all bundled up into one handy package.

Our bundles are ideal for users with a range of needs including switching skills, tracking skills and gross motor skills. Please see the table below for our full list.



Skills	IRiS Soundboard Bundle	IRiS Bubble Tube Bundle	IRiS Bubble Wall Bundle	IRiS Fibre Optic Bundle
Tactile	✓	✓	✓	✓
Cause and Effect	✓	✓	✓	✓
Colour Recognition	✓	✓	✓	✓
Switching Skills				
Dexterity	✓	✓	✓	✓
Vocalisation				
Gross Motor Skills	✓	✓	✓	✓
Fine Motor Skills				
Matching Skills	✓			
Social Skills	✓			
Balance Skills				
Group Participation	✓			

All our products are powered using mains voltage which is transformed to a safer low voltage unless otherwise stated. We offer a 3 Year warranty on all products, giving you peace of mind.

IRiS Soundboard Bundle

Wirelessly interact with the IRiS Soundboard Bundle. This Bundle is ideal to aid in development of sound and language skills with groups or individuals of all abilities. The IRiS Qube features clear sleeves on each side, which allows you to insert an item or image of your choice that corresponds with one of 8 images displayed on the Soundboard which illuminate and play. This bundle is great to develop matching skills. Just roll the Qube to hear the corresponding sound played by the Soundboard. The Soundboard includes 64 pre-recorded sounds, musical clips and noises, with the option to specifically tailor another 16 sounds, making it unique to your requirements.

Dimensions: IRiS Soundboard - 1380mm W x 130mm D x 820mm H.
IRiS Qube - 200mm Square

Please Note: The IRiS Qube is powered by a 9v PP3 replaceable battery (supplied). Also, while the Soundboard is portable, we recommend wall mounting as all fittings are included.

IRiS Soundboard & Qube Bundle
122 01 00 70 **£1472.00**

IRiS LED Bubble Tube Bundle

Introduce the state-of-the-art wireless IRiS range for the best interactive learning with this brilliant bundle. This bundle comes complete with large 1.5m IRiS Bubble Tube, IRiS Recordable Speaker and IRiS 200m Qube, which operates from a distance of 30m – fantastic in larger rooms. To develop colour recognition and cause and effect skills, users can roll the Qube and whichever colour is displayed on the top, is then shown within the 150mm wide Bubble Tube. The colour is then announced by the Recordable Speaker. The Speaker includes 64 pre-recorded sounds, musical clips and noises, with the option to specifically tailor another 16 sounds, making it unique to your requirements.

Please Note: The Recordable Speaker and Bubble Tube are mains powered, which is transformed to a safer low voltage, while the Qube uses a 9V PP3 Battery which is supplied. This Bubble Tube is 150mm in diameter.

IRiS LED Bubble Tube and Qube Bundle
122 01 00 81 **£1,649.00**
Bubble Tube Bracket for 150mm tubes
122 02 00 03 1 **£44.99**



IRiS LED Bubble Wall Bundle

The perfect interactive bundle to aid learning and development.

This features a super soft multi-coloured IRiS Qube that when rolled up to a distance of 30m, the colour that's displayed on top of the Qube, is then displayed on the Bubble Wall and also announced on the Recordable Speaker. There's also the option to record additional sounds on the speaker to make the experience more unique and better tailored to the user. It's a fun interactive bundle that users will love to get involved in. Please Note: This bundle is compatible with any IRiS Talker for added flexibility. The IRiS Qube is powered by a 9v PP3 replaceable battery (supplied) and the IRiS Recordable Speaker and LED Bubble Wall are powered using mains voltage which is transformed to a safer low voltage.

Dimensions: IRiS Recordable Speaker - 140mm W x 220mm D x 55mm H
IRiS Qube - 200mm x 200mm x 200mm

IRiS LED Bubble Wall & Qube Bundle
122 15 00 22 **£2,799.00**

IRiS LED Fibre Optic Qube Bundle

Utilise the wireless capabilities of this bundle and control the fibre optics with the IRiS Qube, just roll the Qube for a colour to appear. This product comes complete with a battery powered IRiS Qube and works with any IRiS talking device (Other IRiS products sold separately). This also comes in a calming mode as standard which gently scrolls through eight vibrant colours to relax the senses.

Please Note: LED lightsource is included and comes with 150 standard 2000mm strands. The LED lightsource is mains powered, which is transformed to a safer low voltage, while the Qube uses a 9V PP3 Battery which is supplied.

IRiS LED Fibre Optic Qube Bundle
122 15 00 12 **£1162.00**

Balance Skills

Build users' balance, coordination, gross motor skills and colour recognition skills with this handy bundle. The Balance Skills Bundle comprises an IRiS Balance Beam which is powered by four AA batteries (supplied) and an IRiS LED Light Spreader which operates on mains voltage. Improve balance in users and encourage them to walk along the IRiS Balance Beam, with the resulting reward of a light colour change that's emitted from the IRiS LED Light Spreader, flooding any sensory space with bright, illuminating light. Utilise the IRiS Balance Beam in your soft play room and add another level of interaction. Users can stand on one of the 8 large, brightly coloured sections and control any IRiS Listener (available separately). The IRiS Balance Beam is covered in soft, durable vinyl that's easy-to-clean and maintain. The IRiS LED Light Spreader is a compact unit that casts wide circles of bright light in a range of 8 colours.

Dimensions: IRiS Balance Beam - 650mm D x 2000mm W x 500mm H.
IRiS LED Light Spreader is wall mounted (bracket supplied)

IRiS Balance Beam Set 122 01 00 41 **£2144.00**



Switching Skills

The ideal bundle for developing a huge range of key life skills. This Bundle comprises an IRiS LED Bubble Tube which operates on mains voltage, as well as the IRiS Colour Selector Deluxe, which is Qi charging, meaning there's no battery to change.

The wireless controller (included) lets users control the bubble tube remotely and features 8 switch modes including: 'locked', 'toggle', 'momentary', 'racing', 'passive', 'timed', 'scroll stop' and 'scroll next'.

These modes aid development of switching skills, cause and effect skills, colour recognition, turn taking, social interaction, anticipation, as well as fine and gross motor skills.

The IRiS LED Bubble Tube features a beautiful display of calming water, invigorating bubbles and a range of 8 coloured light modes encased within a durable tube. It also responds whenever the wireless controller is activated. This Bundle is accessible to all, featuring 8 colour coded 6.5mm jack sockets which allow the user's favourite switches to be connected.

Dimensions: The Bubble Tube is 150mm in diameter and 1.5m height.

Switching Skills 122 15 00 17 **£2750.00**

Vocalisation Skills

Encourage vocalisation skills with this unique bundle. This Bundle comprises an IRiS Sound Switch which is Qi charging, meaning there's no battery to change, as well as an IRiS LED Bubble Tube which operates on mains voltage. The wireless controller (included) lets users control the bubble tube remotely and boasts four switching modes: 'locked', 'momentary', 'scrolling' and 'sound responsive'. These aid the development of switching skills, cause and effect skills, colour recognition, turn taking, social interaction, anticipation, as well as fine and gross motor skills. The Ultra-sensitive IRiS Sound Switch can detect any sound and the sensitivity controller allows the Sound Switch to be easily adjusted for users of all abilities.

The IRiS LED Bubble Tube features a stunning display featuring calming water with invigorating bubbles and responds whenever the wireless controller is activated.

Dimensions: This Bubble Tube is 150mm in diameter and 1.5m height.

Vocalisation Bundle 122 15 00 19 **£1584.00**

Tracking Skills

A brilliant way to develop tracking skills in a fun way. This bundle is an excellent resource to develop colour and shape recognition, cause and effect skills, hand to eye coordination and switching skills.

The Tracking Skills Bundle comprises an IRiS Light Wand, powered by four AA batteries (supplied) and an IRiS LED Scanner, which operates on mains voltage. Using the IRiS Light Wand, users can press a large button to move the light emitted from the IRiS LED Scanner around a room, as well as change the colour and shape shown. This bundle is also easily accessible as users can connect their own switch via the 3.5mm jack socket.

Dimensions: IRiS Light Wand - 220mm D x 140mm W x 75mm H.
IRiS LED Scanner is wall mounted (bracket supplied)

Tracking Skills 122 15 00 13 **£2084.50**

Tel: 0800 612 6077 | www.experia.co.uk

Sensory Room Packages



Following more than 30 years of experience and collaboration with some of the best health professionals in the world, we have carefully crafted a stunning range of sensory environment packages. We offer innovative and exciting features for everyone, regardless of ability or age.

It is quick and easy way to create your complete sensory area, which will be designed to your specific requirements. Simply choose the packages that best suit the needs of your users and we will advise you from there.

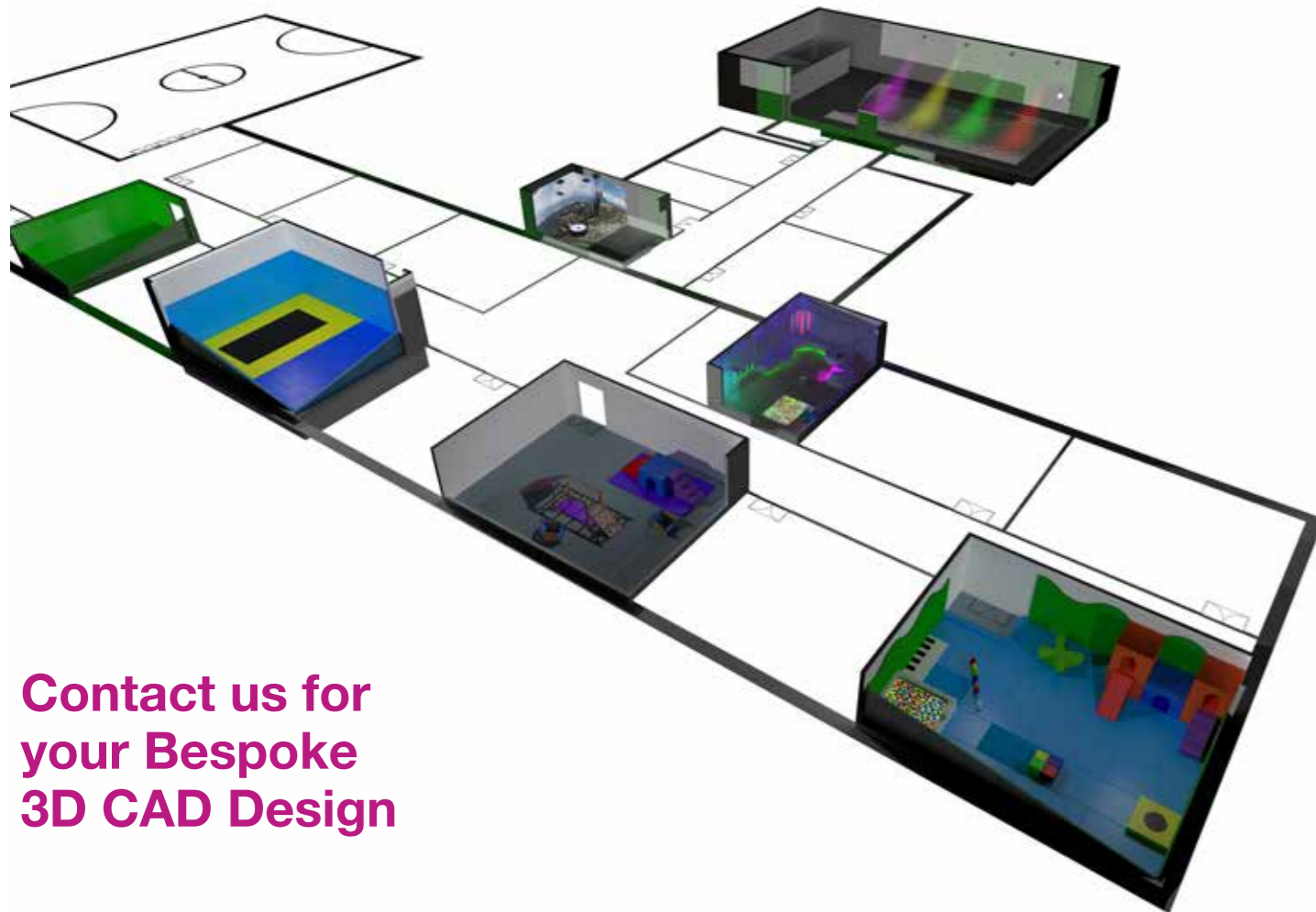

Contact us for your Bespoke 3D CAD Design





Anguli The sensory corner

The perfect place to start your sensory journey. Complete with stylish multi-level plinths on which to sit and enjoy the relaxing effects of the bubble tube, fibre optics, slowly rotating images and your choice of music.

Users can interact with the colours in the room via the wireless Superactive controller, to develop a variety of life-skills such as cause and effect, switching skills and colour recognition.

The versatility of the Anguli means it can fit into most room types.

Uses

Cause and Effect, Colour Recognition, Development of Choice, Interaction & Relaxation, Social Interaction, Switching Skills.

Anguli 122 04 00 34

£4495.00

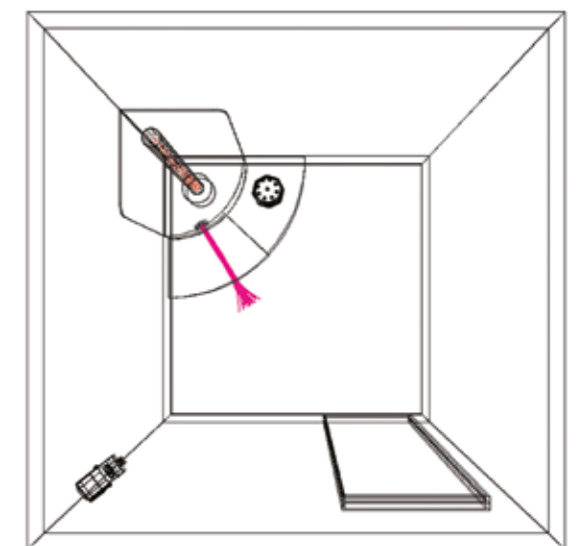



Pioppi The interactive plinth

A compact, stylish plinth that boasts integral switches designed to develop life skills; this package is perfect for when space is tight or if you're looking to integrate sensory facilities into a multi-use room. Get up close to the bubble tube and feel its vibrations, or sit either side in pairs to work on colour recognition, turn-taking or social interaction skills.

The Pioppi can fit into any room regardless of its shape.

Uses

Cause and Effect, Colour Recognition, Development of Choice, Interaction & Relaxation, Social Interaction, Storytelling, Switching Skills, Theming, Turn-Taking.

Pioppi 122 04 00 06

£4995.00

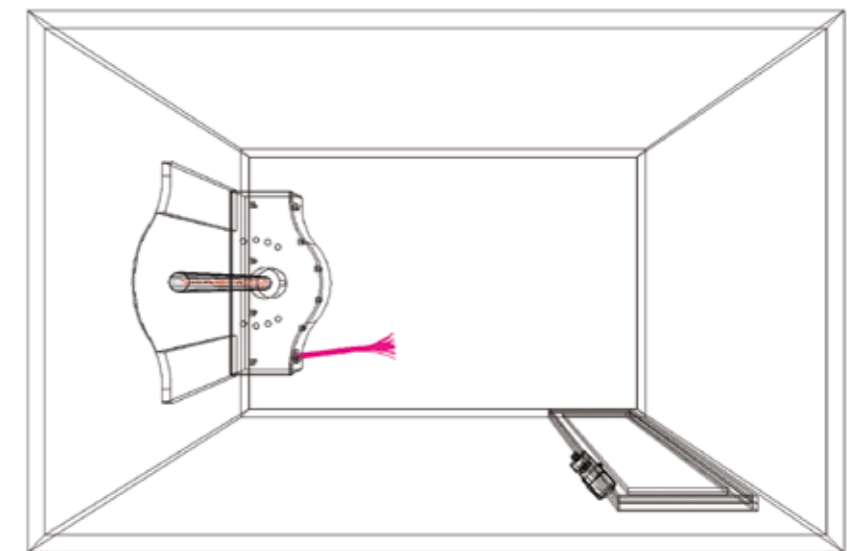



Lagom The intensive interactive sensory room

Step your multisensory experience up a level with the Lagom sensory environment, which introduces a wider range of interactive products in order to continue to inspire the imagination. Each item in the room comes with its own wireless controller to allow multiple users to develop crucial life skills at the same time, whether that's working individually on their own goals simultaneously, or together in groups to encourage social interaction.

Uses

Cause and Effect, Colour Recognition, Development of Choice, Fine Motor Skills, Gross Motor Skills, Hand/Eye Coordination, Interaction & Relaxation, Shape Recognition, Social Interaction, Switching Skills, Theming, Tracking Skills, Turn-Taking.

Lagom 122 04 00 31

£11495.00

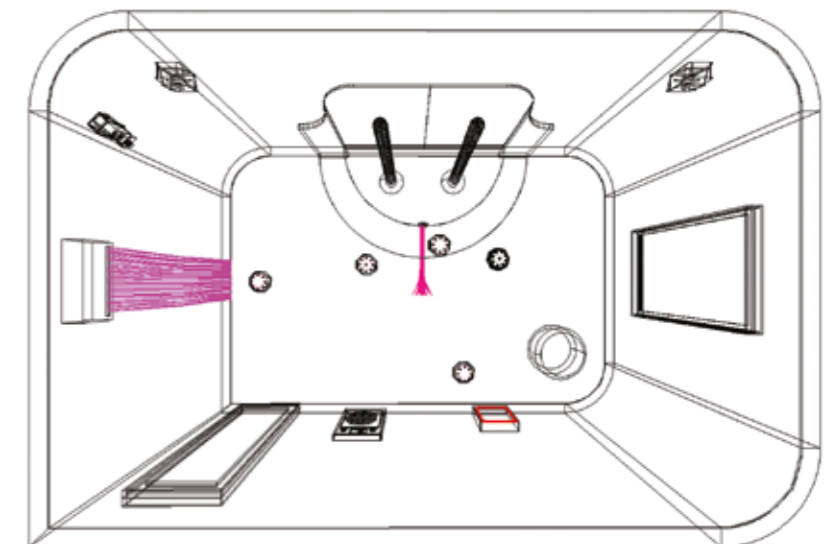



Hygge The professionals' IRiS sensory room

Loved by professionals worldwide, Hygge is truly unique. Featuring a range of IRiS multisensory equipment that allows anyone regardless of age or ability to control each and every piece of equipment through a range of specially designed wireless switches, each and every person gets a personalised reward so they are more willing to work. Easy to use and completely open-ended, products we build now will still be controllable from products we make in 2050!

Uses

Cause and Effect, Colour Recognition, Communication Skills, Concentration, Development of Choice, Fine Motor Skills, Gross Motor Skills, Hand/Eye Coordination, Interaction & Relaxation, Number Recognition, Shape Recognition, Social Interaction, Storytelling, Switching Skills, Theming, Tracking Skills, Turn-Taking.

Hygge 122 04 00 30

£18995.00

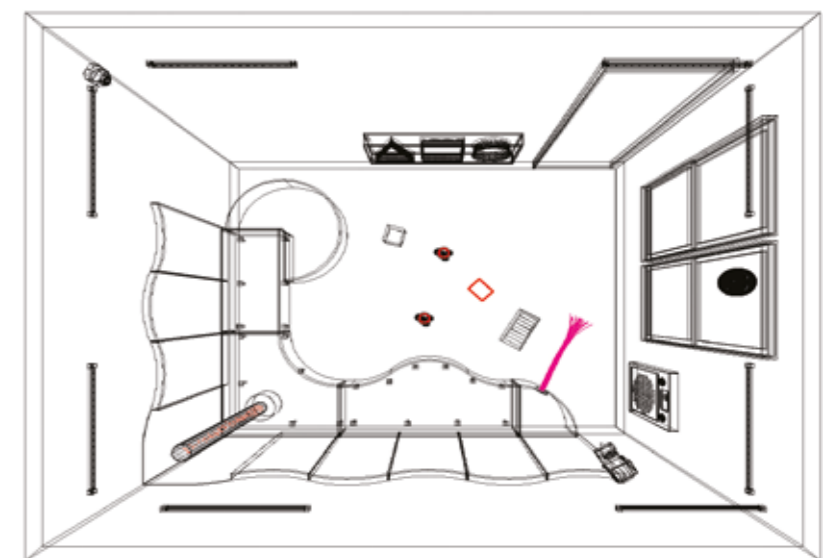



Lykke The app-controlled sensory room

Control every product in the room wirelessly using your iPad or iPhone and our unique app (android app available soon).

The app features 12 different switching modes allowing the user to control the room via sound, touch, rotation and more. This is the ideal package to develop numerous life skills including colour recognition, vocalization, fine motor control and hand-eye coordination to name but a few.

Uses

Cause and Effect, Colour Recognition, Communication Skills, Concentration, Development of Choice, Fine Motor Skills, Hand/Eye Coordination, Interaction & Relaxation, Number Recognition, Shape Recognition, Social Interaction, Switching Skills, Theming, Tracking Skills, Turn-Taking.

Lykke 122 04 00 14

£9995.00

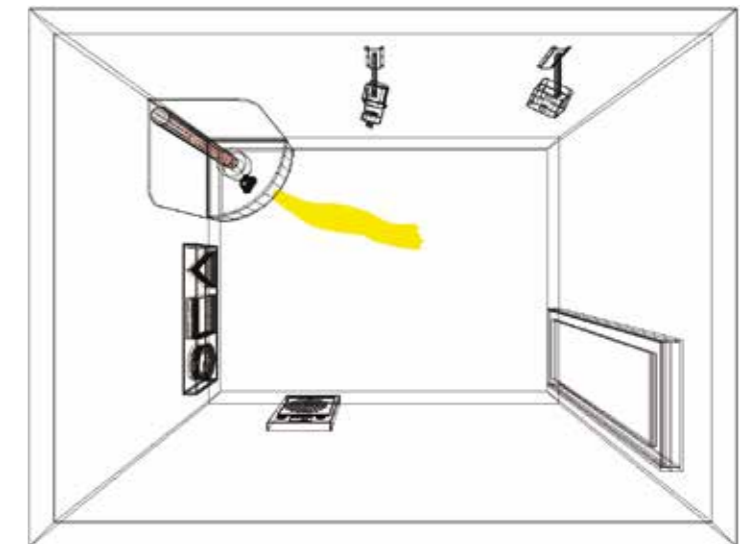

Portable



Our range of portable equipment is ideal for use in environments with limited space or where equipment needs to be moved regularly.

Designed for ease of use in a range of settings including hospitals, classrooms or at home, our range of portable sensory equipment is equipped with the latest LED technology, fibre optics and projection for an enhanced experience for users of all abilities.



Users can also benefit from additional options which feature our innovative IRiS and IRiS+ wireless technology that controls the equipment remotely with the bonus of even more ways of interaction.

With IRiS+, a FREE downloadable app allows the equipment to be controlled wirelessly using any mobile device via touch, voice, vibration or rotation, giving the user even more flexibility.

- 3 Year Warranty on all units, giving you peace of mind.
- All wireless controllers feature Qi charging so there's no battery to change.
- All units are powered using mains voltage and are powered from a single outlet.

Skills	Calming Sensory Cart	Superactive Sensory Cart	IRiS+ Sensory Cart	Calming Sensory Roamer	Superactive Sensory Roamer	Calming Sensory Portare	Superactive Sensory Portare	IRiS Sensory Portare	IRiS+ Sensory Portare	Calming Sensory Corner	Superactive Sensory Corner	Calming Bubble Tube Corner	Superactive Bubble Tube Corner
Relaxation	✓	✓	✓	✓	✓	✓	✓	✓	✓	✓	✓	✓	✓
Tactile	✓	✓	✓	✓	✓	✓	✓	✓	✓	✓	✓	✓	✓
Cause and Effect		✓	✓		✓		✓	✓	✓		✓		✓
Colour Recognition		✓	✓		✓		✓	✓	✓		✓		✓
Switching Skills		✓	✓		✓		✓	✓	✓		✓		✓
Dexterity		✓	✓		✓		✓	✓	✓		✓		✓
Distraction Therapy	✓	✓	✓	✓	✓	✓	✓	✓	✓	✓	✓	✓	✓
Vocalisation			✓		✓			✓	✓				
Gross Motor Skills			✓		✓			✓	✓				
Fine Motor Skills			✓		✓			✓	✓				
Hand to Eye Coordination			✓		✓			✓	✓				
Social Skills			✓		✓			✓	✓				
Balance Skills			✓		✓			✓	✓				
Group Participation			✓		✓			✓	✓				
Tracking Skills	✓	✓	✓	✓	✓	✓	✓	✓	✓	✓	✓	✓	✓

Sensory Cart

Jam-packed full of brilliant state-of-the-art equipment, the Sensory Cart is the ideal portable sensory solution when space is limited.

It's easy to move from room to room thanks to its lockable casters, making it the ideal domestic solution for users with sensory needs, and is particularly effective for those who are bed bound.

Suited to both adults and children alike, the Sensory Cart can be utilised in a range of settings and is a firm favourite in schools, care homes, nursing homes, hospitals, hospices and at home, where it can be used for reminiscence, de-escalation and to create a calming environment.

The inbuilt DVD player and screen, means the Sensory Cart is great to use in a classroom setting, bedroom, common room or on a ward.

The Sensory Cart comes in three versions, each designed with a specification to suit a different purpose.



Portable



Sensory Cart - Calming

A Calming version of the Sensory Cart, this unit has been specifically designed to provide a relaxing, calming respite for users and also works well for de-escalation situations.

The Calming Sensory Cart includes:

- Calming LED Bubble Tube: both visually attractive and very relaxing.
- Calming Fibre Optic Sideglow: perfect for those with a visual impairment; users can hold the fibres close to the eye and appreciate the tactile sensation in their hand and stimulating lights which calm and soothe.
- TV screen: ideal for reminiscence and distraction.
- DVD Player: allow the user to play a film of their choice.
- Aurora LED Projector with liquid wheel: shine this onto the wall, ceiling or floor to create a distracting and calming effect instantly.
- Integral Bluetooth amplifier and speakers with gesture control, making it even easier to play relaxing music of your choice.
- Twin wheel castors: these enable the unit to be moved easily from one room to another, meaning you can quickly get the equipment to where it is needed.
- High quality, strong and durable plywood construction: overlaid with hard-wearing, durable melamine film with a smooth, semi-gloss surface, the unit is maintenance free, hygienic and easy to clean.

Dimensions: 650mm W x 990mm H x 530mm D.

Sensory Cart - Calming

122 61 00 05

£2,325.00

Sensory Cart - Superactive

A Sensory Cart with wireless controller designed to develop cause and effect skills in the home, classroom or sensory room.

It includes:

- Superactive LED Bubble Tube: both visually attractive and interactive, use this to develop cause and effect, as well as colour recognition skills.
- Superactive Fibre Optic Sideglow: perfect for those with a visual impairment; users can hold the fibres close to the eye and appreciate the tactile sensation in their hand and stimulating lights which calm and soothe.
- Superactive LED Infinity Tunnel: creates the illusion of lights that slowly change colour and continue into the distance creating a mesmerising effect.
- Superactive Wireless Controller: ideal for developing colour recognition and switching skills.
- Aurora LED Projector with liquid wheel: shine this onto the wall, ceiling or floor to create a distracting and calming effect instantly.
- Integral Bluetooth amplifier and speakers with gesture control, making it even easier to play relaxing music of your choice.
- Interactive unit that also features a calming mode that aids relaxation and self-regulation.
- Twin wheel castors: these enable the unit to be moved easily from one room to another, meaning you can quickly get the equipment to where it is needed.
- High quality, strong and durable plywood construction: overlaid with hard-wearing, durable melamine film with a smooth, semi-gloss surface, the unit is maintenance free, hygienic and easy to clean.

Dimensions: 650mm W x 990mm H x 530mm D.

Sensory Cart - Superactive

122 61 00 06

£2,899.00

Sensory Cart - IRiS+™

Control this Sensory Cart wirelessly with almost any mobile device (iPad, tablet or phone) using our comprehensive app to develop a variety of lifeskills.

It features 10 switch modes including touch, sound, vibration, rotation and relaxation so is ideal for users of all ages and abilities.

It includes:

- IRiS+ LED Bubble Tube: both visually attractive and interactive, use to develop cause and effect and colour recognition skills.
- IRiS+ Fibre Optic Sideglow: perfect for those with a visual impairment; users can hold the fibres close to the eye and appreciate the tactile sensation in their hand and stimulating lights which calm and soothe. Works wirelessly using your tablet or other mobile device.
- IRiS+ LED Infinity Tunnel: creates the illusion of lights that slowly change colour and continue into the distance creating a mesmerising effect.
- Aurora LED Projector with liquid wheel: shine this onto the wall, ceiling or floor to create a distracting and calming effect instantly.
- Integral Bluetooth amplifier and speakers with gesture control, making it even easier to play relaxing music of your choice.
- Features a calming mode that aids relaxation and self-regulation.
- Twin wheel castors: these enable the unit to be moved easily from one room to another, meaning you can quickly get the equipment to where it is needed.
- High quality, strong and durable plywood construction: overlaid with hard-wearing, durable melamine film with a smooth, semi-gloss surface, the unit is maintenance free, hygienic and easy to clean.

Sensory Cart - IRiS+ 122 61 00 07

£2,999.00

Sensory Roamer

The Sensory Roamer is the ideal portable sensory solution when space is limited.

It's easy to move from room to room thanks to its lockable casters, making it the ideal domestic solution for users with sensory needs, and is particularly effective for those who are bed bound.

This product features an LED Bubble Tube which is 120mm in diameter and 1m high making it a focal point in any sensory space. The LED Fibre Optic Lightsource and fibre optic strands create a stunning visual display while being both tactile and safe to touch.

There are two versions of this product available, each designed with a specification to suit a different purpose.



Sensory Portare

The Sensory Portare is ideal in a classroom setting where additional sensory equipment is needed locally, in a care home where space is limited or on a hospital ward.

This stylish unit glides easily from one room to another, enabling you to move sensory equipment to where it is most needed. The unit features lockable wheels, steering handles, shelves, lockable cabinet, a power socket and RCD (residual current device) for protection.



Sensory Roamer - Calming

Aiding in relaxation, this unit features:

- Calming LED Bubble Tube: both visually attractive and very relaxing.
- Calming Fibre Optic Sideglow: perfect for those with a visual impairment; users can hold the fibres close to the eye and appreciate the tactile sensation in their hand and stimulating lights which calm and soothe.
- Aurora LED Projector with liquid wheel: shine this onto the wall, ceiling or floor to create a distracting and calming effect instantly.

Dimensions: 450mm W x 1000mm D x 1200mm H.

Sensory Roamer - Calming

122 61 00 11

£1,429.00

Sensory Roamer - Superactive

Perfect for stimulation, this version includes:

- Superactive LED Bubble Tube: both visually attractive and interactive, use this to develop cause and effect, as well as colour recognition skills.
- Superactive Fibre Optic Sideglow: perfect for those with a visual impairment; users can hold the fibres close to the eye and appreciate the tactile sensation in their hand and stimulating lights which calm and soothe
- Superactive Wireless Controller: ideal for developing colour recognition and switching skills.
- Aurora LED Projector with liquid wheel: shine this onto the wall, ceiling or floor to create a distracting and calming effect instantly.

Dimensions: 450mm W x 1000mm D x 1200mm H.

Sensory Roamer - Superactive

122 61 00 12

£1,979.00

Sensory Portare - Calming

Ideal for relaxation, this package includes:

- 1 x Calming LED Bubble Tube – 1m
- 1 x LED Fibre Optic Lightsource
- 1 x Fibre Optic Sideglow -2m x 100 strands
- 1 x Aurora LED Projector
- 1 x Wheel Rotator
- 3 x 6" Effect Wheels
- 1 x Aroma Diffuser
- 1 x Aroma Starter Kit
- 1 x Bluetooth Sound System
- 3 x Acrylic Mirrors

Dimensions: 500mm W x 740mm L x 1700mm H.

Sensory Portare - Calming 122 61 00 03 **£2,749.00**

Sensory Portare - Superactive

Best for stimulation, this package includes:

- 1 x Interactive LED Bubble Tube (1m H)
- 1 x 9-way Wireless Controller
- 1 x Interactive LED Fibre Optic Lightsource
- 1 x Fibre Optic Sideglow (2m x 100 strands)
- 1 x Aurora LED Projector
- 1 x Wheel Rotator
- 3 x 6" Effect Wheels
- 1 x Aroma Diffuser
- 1 x Aroma Starter Kit
- 1 x Bluetooth Sound System
- 3 x Acrylic Mirrors

Dimensions: 500mm W x 740mm L x 1700mm H.

Sensory Portare - Superactive

122 61 00 01

£3,199.00



Sensory Portare - IRiS

A brilliant tool for developing colour recognition, cause and effect, as well as switching skills. Take full control of your Sensory Portare with Experia's revolutionary IRiS (Interactive Reward System) wireless technology. This package is super flexible, user friendly and easily expandable, allowing your sensory room to be quickly refreshed so users can enjoy a new experience every day. Additionally, new IRiS items can be added at a later date if desired.

- The package includes:**
- 1 x IRiS LED Bubble Tube - 1m
 - 1 x IRiS LED Lightsource
 - 1 x Fibre Optic Sideglow - 2m x 100 strands
 - 1 x IRiS Colour Selector
 - 1 x IRiS Soundswitch
 - 1 x IRiS Single Switch
 - 1 x Aurora LED Projector
 - 1 x Wheel Rotator
 - 3 x 6" Effect wheels
 - 1 x Aroma Diffuser
 - 1 x Aroma Starter Kit
 - 1 x Bluetooth Sound System
 - 3 x Acrylic Mirrors

Dimensions: 500mm W X 740mm L x 1700mm H.

Sensory Portare - IRiS
122 61 00 04 **£4,289.00**

Sensory Portare - iRiS+™

Using the free downloadable app available from your App Store: Experia iRiS+. Perfect for developing a variety of key skills, please see the skills table.

- The package includes:**
- 1 x iRiS LED Bubble Tube
 - 1 x iRiS LED Fibre Optic Lightsource
 - 1 x Fibre Optic Sideglow - 2m x 100 strands
 - 1 x iRiS+ App
 - 1 x Aurora LED Projector
 - 1 x Wheel Rotator
 - 3 x 6" Effect Wheels
 - 1 x Aroma Diffuser
 - 1 x Aroma Starter Kit
 - 1 x iPod* Docking Station
 - 3 x Acrylic Mirrors

Please Note: *iPod, iPad and iPod Touch (not included) needed to control the Sensory Portare IRiS+

Dimensions: 500mm W x 740m L x 1700mm H.

Sensory Portare - iRiS+
122 16 00 07 **£3,849.00**



Portable Sensory Corner

The Portable Sensory Corner can be easily moved from room to room, offering a comfortable place for users to sit while the fibre optic strands and bubble tube provide a great visual display to enjoy.

The fibre optic carpet panel features hundreds of spot lights which change colour, creating a bright and engaging experience for the user. Ideal for relaxation or promoting a calm atmosphere, the bubble tube can also be utilised to aid in de-escalation situations for individuals with dementia.

- This unit includes:**
- A plinth manufactured from a strong, durable and soft touch vinyl (please state colour when ordering)
 - LED Bubble Tube (1m high)
 - Fibre Optic Sideglow (2m x 100 strands)
 - Fibre Optic Carpet Panel
 - Two Acrylic Mirrors
 - Lockable Wheels

The Portable Sensory Corner can either be calming or interactive depending on the model chosen. The interactive model includes a battery powered wireless featuring Qi charging so there's no battery to change.

Dimensions: 700mm W x 1250mm L x 400mm H.

Portable Sensory Corner - Calming
122 63 00 05 **£3,299.00**

Portable Sensory Corner - Superactive
122 63 00 06 **£4,399.00**

Portable Bubble Tube Corner

The Portable Bubble Tube Corner features a soft padded platform that allows the user to sit up close to the Bubble Tube and feel its vibrations, while two acrylic mirrors reflect the tube to create a magical illusion.

Ideal for the classroom, hospital or home, the corner features a 1.5m high LED Bubble Tube which slowly scrolls through a range of colours until activated.

The unit can be either calming or interactive depending on the model chosen. The interactive model includes a battery powered wireless featuring Qi charging so there's no battery to change.

Dimensions: 900mm W x 900mm L x 400mm H.

Portable Bubble Tube - Calming
122 63 00 07 **£1,649.00**

Portable Bubble Tube - Superactive
122 63 00 08 **£1,869.00**



De-escalation Room



A De-escalation room is an essential space to provide calm and help users to manage their emotions.

This specifically designed environment uses calming sounds and gentle lighting to help users in crisis and can help avoid the need for restraint.

It is a neutral, safe space where one to one conversations can take place.



Calming LED Lighting Bundle

Users can enjoy slowly changing colours with the Calming LED Lighting Bundle to promote a relaxing environment. This bundle is exceptionally easy to use with the wall mounted controller (included) and provides a lovely soothing effect for the user.

As part of this bundle, the lights are also dimmable and users can also choose from a range of colours, as well as control the speed at which the colours scroll through.

This bundle comes in 2 versions:

Recessed:

LED spots that are recessed into a ceiling. This comprises a Controller, driver and 4 x recessed LED spots.

Surface:

LED Strips that are mounted onto a wall or ceiling. This comprises a Controller, driver and 6 x surface mounted LED strips.

Calming Lighting Bundle - Recessed

122 48 00 38 **£799.00**

Calming Lighting Bundle - Surface

122 48 00 39 **£1099.00**



Bluetooth Amplifier System

A Bluetooth music system with touch sensitive panel and contactless gesture control. This unit has an inbuilt Bluetooth audio receiver, which broadcasts high quality wireless music streaming from any Bluetooth enabled mobile device. Just connect any device to the unit using the easily accessible front panel mounted jack socket.

The Bluetooth Amplifier System offers superb sound quality with a superior stereo sound stage that's delivered from separate left and right installed ceiling speakers (included).

Bluetooth Amplifier System

122 49 00 13

£714.00



Soft Wall Pads

Our Soft wall padding is used to ensure an area is safe, fun and bright for users of all abilities, whilst providing a comfortable area to enjoy our products. Please specify your colour choice when ordering. See pages 178-179 for colour options. We offer the three standard sizes shown below or bespoke sizes are available on request.

Small - 1270mm L x 1270mm W x 70mm D

122 32 00 10 1 **£290.00**

Medium - 1270mm L x 1800mm W x 70mm D

122 32 00 10 2 **£411.00**

Large - 1270mm L x 2440mm W x 70mm D

122 32 00 10 3 **£549.00**



Soft Floor Pad

Our Soft floor padding is ideal in de-escalation situations as it provides a safe, soft surface to comfort users of all abilities. Please specify your colour choice when ordering. See pages 178-179 for colour options. We offer the three standard sizes shown below or bespoke sizes are available on request.

Small - 1270mm L x 1270mm W x 100mm D

122 32 00 11 1 **£290.00**

Medium - 1270mm L x 1800mm W x 100mm D

122 32 00 11 2 **£411.00**

Large - 1270mm L x 2440mm W x 100mm D

122 32 00 11 3 **£549.00**



Not sure where to start?

We have designed three packages, with the details mentioned below. Please contact us if you would like a bespoke design.

Sangfroid The De-escalation Room

Sometimes we all need some time and space but for people with special needs it can be hard to express emotions until they hit breaking point. This wonderful package has been designed as a safe place to go for those who need to de-escalate and calm. Padding covering the walls and floor ensures users can't hurt themselves whilst in the room.

Uses
Calming, De-escalation.

Sangfroid 122 04 00 15

POA





Zen The Premium De-escalation Room

The next step up from our standard de-escalation package, this has the added benefits of slowly colour changing lighting and a choice of music, perfect for calming and relaxation. Allow the user to hide away and self-regulate in a safe environment until they are ready to face the world again.

Uses
Calming, De-escalation.

Zen 122 04 00 16

POA

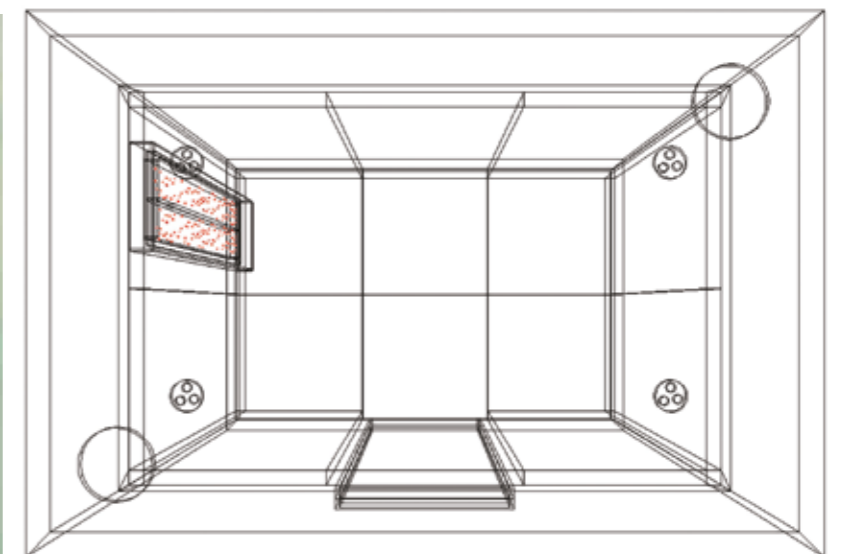



Uitwaaien

The specialist high dependency de-escalation room

A distracting immersive experience for users who need that additional support, this is the ultimate in de-escalation. What calms and relaxes one person is different from the next, so this package allows you to create themes to suit each individual through the use of synchronised colour change, music and video. It also features soft padded walls and floors to allow users to release their negative energy, which when combined with specialised themes, makes this package the ultimate in de-escalation.

Uses

Calming, Communication Skills,
De-escalation, Distraction Therapy, Reminiscence.

Uitwaaien 122 04 00 22

£18995.00

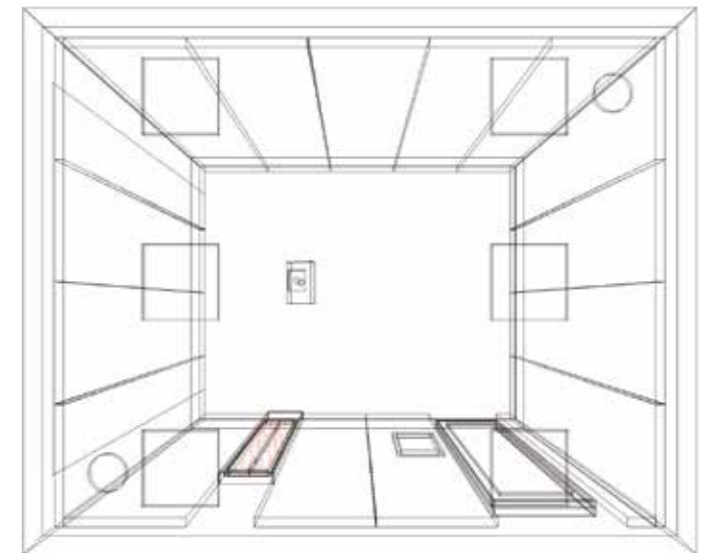

Rebound Therapy



Rebound Therapy is a specific model of trampoline therapy:- exercise therapy which uses a full sized trampoline to provide opportunities for movement, therapeutic exercise and recreation for people across virtually the whole spectrum of special needs.

‘December 2021 www.reboundtherapy.org’



Soft Wall Pads

Add colour and extra safety to soft play walls. Soft wall padding is used to ensure an area is safe, fun and bright. Please specify your colour choice when ordering. See page 178-179 for colour options. We offer three standard sizes shown below or bespoke sizes are available on request.

Small - 1270mm L x 1270 W x 70mm D	
122 32 00 10 1	£290.00
Medium - 1270mm L x 1800 W x 70mm D	
122 32 00 10 2	£411.00
Large - 1270mm L x 2440 W x 70mm D	
122 32 00 10 3	£549.00

Soft Floor Pad

A comfortable, colourful and cushioned addition to your soft play room. Soft floor padding provides a safe, soft surface within a Rebound Therapy space or can be used as a comfortable area for physiotherapy sessions. Please specify your colour choice when ordering. See page 178-179 for colour options. We offer the three standard sizes shown below or bespoke sizes are available on request.

Small - 1270mm L x 1270 W x 100mm D	
122 32 00 11 1	£290.00
Medium - 1270mm L x 1800 W x 100mm D	
122 32 00 11 2	£411.00
Large - 1270mm L x 2440 W x 100mm D	
122 32 00 11 3	£549.00



Trampoline

This carefully designed trampoline is fantastic for rebound therapy. It features a supermesh material that is wipe clean and can be used with anti-bacterial spray to ensure its always hygienic and ready to use. It comes complete with 32mm thick surround pads, high tensile steel springs and either standard fixed or lift/lower rollerstands which assist in the folding and unfolding of the trampoline and allows it to fit through a standard height door when in the lowered position. Manufactured in the UK to conform to BSEN 13219. Two versions are available: Fixed and movable. Surround pads are available in a wide range of PVC colours, Please specify your colour choice when ordering. See page 178-179 for colour options.

Dimensions:

Nominal frame size - 4.6m x 2.74m x 0.99m
 Nominal bed size - 3.6m x 1.8m
 Folded frame size 2.74m x 1.96m
 (when lowered with lift/lower rollerstands) x 0.25m

Junior Trampoline - Fixed	
122 32 00 02 1	£5155.00
Junior Trampoline - Movable	
122 32 00 02 2	£5155.00

Specialist Advice

We have many years experience and offer comprehensive advice to ensure you get the very best room to meet your needs. We pride ourselves on our specialist planning and installation for existing and new build rooms. Contact us to discuss your requirements.



Kanga The rebound therapy room

A dedicated room in which to provide rebound therapy, this package comes complete with soft wall and floor padding for increased safety. The trampoline facilitates movement, promotes balance, improves fitness and exercise tolerance, and can be used to increase or decrease muscle tone. It could also be used to improve communication and concentration skills and to aid relaxation and sensory integration. All Experia Soft Play is made to order in your choice of colours, please see pages 178-179.

Uses

Balance, Physical Skills, Rebound Therapy.

Kanga 122 04 00 21

POA



Sensory Bathrooms



For some individuals, bath time is the perfect time to relax and reset, by soaking away the day's stresses. Combined with music gently playing and slowly scrolling lighting, this can be the ultimate in relaxation.

The calming effects of a sensory bathroom can be profound for those with differing abilities. Users can fully relax their muscles, enjoy reduced pain and discomfort and even allow them to explore and develop new skills.



Sulis

For users who find bath time stressful and unnerving, this is the ideal bundle to have. This bundle comes with an IRiS talker and listener and lets users fill the space with bright colourful shapes to create a feeling of instant calm and promote a relaxing environment. Just one

press of the chunky waterproof button will change the colour and shape combination of the projector, allowing the user to control their choices.

Sulis 122 15 00 06

£1,495.00

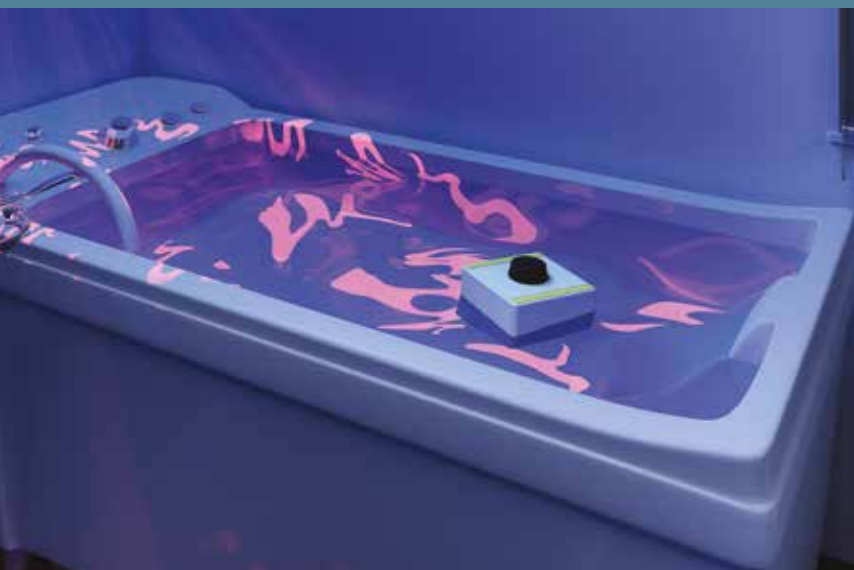

We utilise the very latest LED technology and wireless switching and have created two specific sensory bathroom bundles, each accommodating bathrooms of varying sizes and all catering for users' needs.

Please check with a qualified electrician whether each bundle is suitable for your bathroom prior to purchasing it.

All products in the bundle are either mains operated transformed to a safer low voltage or battery operated (batteries supplied).



Hammam

Explore cause and effect skills with users as the waterproof IRiS Floating Switch that comes with this bundle can be paired with both of the IRiS listeners (provided) to create a wonderful visual effect. Alternatively, users can opt for calming mode which gently scrolls through a range of eight colours to create a wonderfully relaxing atmosphere.

This bundle features a Bluetooth amplifier and speakers, so calming sounds can be heard directly via your mobile device. This bundle features a fibre optic wide bore which brings light directly into the bath beside the user.

Hammam 122 15 00 07

£3,495.00



Sensory Pools



Bring your swimming pool to life with our Sensory Pool systems.

Our sensory pools are totally unique as they can be designed to suit any pool size, purpose and budget, making each system totally bespoke to your needs.

From a calming, relaxing environment to a fully interactive wireless IRiS system, we have the experience to create, design and install the perfect sensory solution for you.



Our options span single switch systems, allowing a user to control pool sound and light, to the groundbreaking IRiS™ Room Director system, which allows the creative use of synchronised light, sound, aroma and video projection to develop different modes for those with special needs.

IRiS™ Room Director can also assist professionals including physiotherapists with their work while providing a fun, exciting experience for users. For example, the movement encouragement mode uses a circle of light to stay within as it moves across the pool. Alternatively, the sound responsive mode is controlled by the noises made by users, changing the colour of lighting or the music played.

The wonderful properties of water reduce pain in some users, thereby allowing more focus on life skills development. Equipment can be controlled from within the pool using our durable wireless floating switches.

A number of themes are available for teaching and play, including Under the Sea, Desert, Forest and everyone's favourite, Space! where you watch in awe as your spaceship enters the stratosphere. See stars and planets pass by as you experience weightlessness and pretend to be moving across the moon.

Our unique drag and drop software enables you to create your own modes, allowing you to design scenarios that are specific to an individual, making every visit to the pool interesting and rewarding.

Our range of water based products have been manufactured to meet the differing users of our system and the challenging environments they are often exposed to. All products are powder coated to help prevent rust while electronic components are protected by a lacquer. All products designed by Experia are guaranteed for three years and most are low voltage.

If you would like more information on our pool systems or would like to take advantage of our free room design and demonstration, please contact us on 0800 617 6077 or email info@experia.co.uk.



Atlantis The sensory pool

Transform your pool into a multisensory experience with this package, making hydrotherapy and movement development more engaging with a variety of lighting and projection effects. Develop gross motor and physical skills in an exciting, stimulating environment which is fully controlled by the user through the wireless floating switches.

Uses

Cause and Effect, Colour Recognition, Development of Choice, Gross Motor Skills, Interaction & Relaxation, Physical Skills, Shape Recognition, Switching Skills, Theming, Tracking Skills.

Atlantis 122 04 00 18

£14995.00

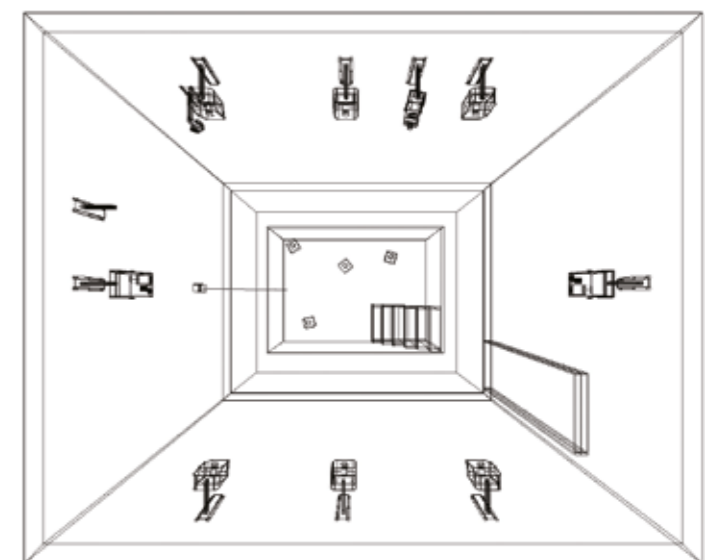



Poseidon The computer-controlled sensory pool

Transform your pool into a spectacular performance of sound and light, controllable through our IP-rated low voltage touchscreen suitable for pool environments. The IRiS software is packed full of themes designed for learning, calming and reminiscence, each of which can be controlled by the user with one of the wireless floating switches. A superb atmosphere for theming, storytelling, social interaction and above all, fun!

Uses

Cause and Effect, Colour Recognition, Development of Choice, Gross Motor Skills, Hand/Eye Coordination, Interaction & Relaxation, Number Recognition, Physical Skills, Shape Recognition, Social Interaction, Switching Skills, Theming, Tracking Skills.

Poseidon 122 04 00 19

£24995.00

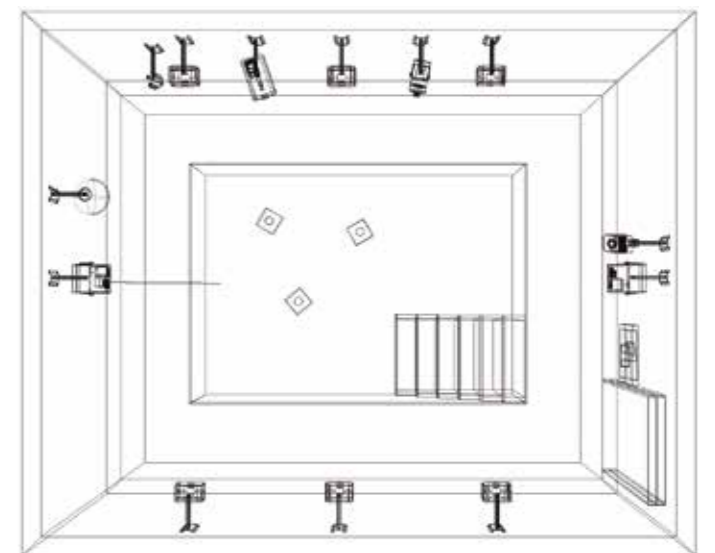

MILE



A sensory learning experience which can be tailored to the needs of the individual regardless of age or ability.

Makes learning more engaging as it combines light, sound, video, vibration, moving air, different aromas and even atmospheric conditions.

Integrates easily with new or existing components from the Experia IRiS range.



M.I.L.E is Experia's exclusive learning system that allows the creation of very specific sensory room experiences which combine light, sound, video, vibration, moving air, different aromas and even atmospheric conditions that are totally personal for each individual regardless of age or ability.

M.I.L.E is a new development in sensory room technology combining a calming sensory room, stimulating sensory room, interactive sensory room and an Interactive learning platform into one easy to use package.

It encourages teachers to be creative with their lessons, bringing the information alive rather than simply reading from a textbook. For example, if you are teaching history why not take your pupils back to the wild west - the smell of gun smoke in your nostrils, the sight of the Pony Express, the noise of a horse's hooves galloping by - whilst videos show what it was really like during the time.

Using Experia's dedicated software which is pre-loaded with a number of scenarios, equipment from the Experia's wireless IRiS (Interactive Reward System) range can be controlled using hands or switches to interact and create an environment that can be used time and again.

M.I.L.E was created following an intensive two-year development programme and the incredible power and flexibility of the system is only made possible by the strength of the software built to drive it. Designed and written specifically for the system with teachers and carers in mind, the IRiS Room Director software ensures the M.I.L.E is used to its full potential using our wireless IRiS products.

The software is based on drag and drop to allow easy creation of scenarios which can be tailored to every subject, theme or story.

You are in complete control of the scenario you want to create.

A large range of media can also be easily integrated into to the system at the click of a mouse, from film clips, photographs and pictures, text and visualisations, as well as existing Microsoft PowerPoint and Opus presentations.

It's also completely versatile and each scenario can be designed to suit an individual and help develop skills including cause and effect, colour, number and shape recognition along with gross and fine motor skills.

"The M.I.L.E. is excellent because you can create environments and make them information based."

Jackie Tiff - Castle Wood School

"The M.I.L.E. provides a great opportunity for them to learn through a sensory experience."

Andy Sloan - Rosehill School



M.I.L.E. allows you to calm or stimulate an individual or develop their life skills in a way that is both personal and rewarding. Here are some examples of applications of M.I.L.E.:

Calming

Just imagine how calming and enjoyable it would be to watch dolphins swimming and leaping out of the water, accompanied by gentle music while the room is flooded in blue lighting and the aroma of the sea fills your nostrils.

Interactive

Activate a switch and your favourite music starts. Activate a different switch and your favourite film begins and the lights change to your favourite colour. This engaging experience encourages users to develop life skills by giving them completely individual rewards.

Stimulation

Dance music plays, lights quickly change colour, the floor vibrates and a video showing partygoers appears on a screen. Let's party!

Drama

Drama is brought to life in an exciting and professional environment. A multitude of lighting effects, sounds, aromas and much more can transform any rehearsal or performance.

Theming

Theming is simply brilliant in a M.I.L.E. The room is flooded with green, the wind gently blows in your hair, a video showing the rainforest appears and you can hear animals moving around you. Start another scenario and the lights turn blue, you hear the sound of seagulls overhead and you can smell the distinct aroma of the sea. A video of a trawler appears and suddenly you're taken to a life on the ocean waves, the floor vibrating as the boat motors on.

Recreation

Be a star and have fun with your own X Factor competition! The lights from the M.I.L.E. change colour and put the performer well and truly in the spotlight. The audience can hear you as you sing your favourite song using a radio microphone and the wind machine blows your hair!

Storytelling

The M.I.L.E. is perfect for storytelling. How about going on a bear hunt? The lights in the room turn green as you smell the cool, wet grass. As you venture into the snow storm, the wind blows through your hair, the lighting turns white and snow buffets around the room.

Teaching

Teaching comes alive in a M.I.L.E! Go back in time to the Blitz and the Second World War. A video projection shows the buildings alight while air raid sirens are heard overhead. The lights flash red and yellow and fog moves across the room as the flames lick the buildings. The smell of burning fills your nostrils as a search light scans for planes. A bomb lands nearby causing the floor to vibrate and the sound to pound the walls. Now it's time to teach! Why did it happen? How did people survive and what was life like after the blitz?

Reminiscence

The M.I.L.E. can take people back in time. If a client once worked in a machine shop, for example, the smell of machine oil fills the air and a film shows a lathe in action. You can talk about how they feel - did they work in a shop like this? Press a switch and their favourite colour and aroma combines with images and a video of their family, giving you and your client an inspiring and safe environment to talk about their loved ones.

Effects

The M.I.L.E. can control many effects including light, sound, aroma, wind, fog, snow, vibration, video, computer and more. There are many items that can be used within the M.I.L.E from the IRIS range. Unlike other systems, the M.I.L.E. doesn't only rely on a computer to work - you can simply use our wireless switches to control equipment. If you are looking for the ultimate sensory room that delivers breathtaking results then the M.I.L.E. will be for you! Call us to arrange a FREE demonstration at your establishment or to visit a M.I.L.E. near you. Visit www.experia-innovations.co.uk or call us on 0845 644 0977.

UV Blacklight



Here at Experia, our UV products are simply mesmerizing to watch. By shining a UV light over our brightly coloured fluorescent products, they immediately burst into life and create magical optical traces in the paths of objects, developing both visual processing and tracking skills for users.

The light trails left by the movement of fluorescent products are both visually striking and fairly easy to produce. UV products glow furiously when exposed to UV light creating a visually stunning result.

- All electrical products are powered using mains voltage which is transformed to a safer low voltage unless otherwise stated.
- Our bubble walls must be mounted to a solid wall and all come complete with fixtures and fittings. They are a strong, easy to clean unit.
- Bubble walls are powered using mains voltage which is transformed to a safer low voltage unless otherwise stated.
- All bubble walls measure 560mm W x 1800mm H x 120mm D
- All wireless controllers feature Qi charging so there's no battery to change.
- We offer a 3 year warranty on all bubble walls, giving you peace of mind.

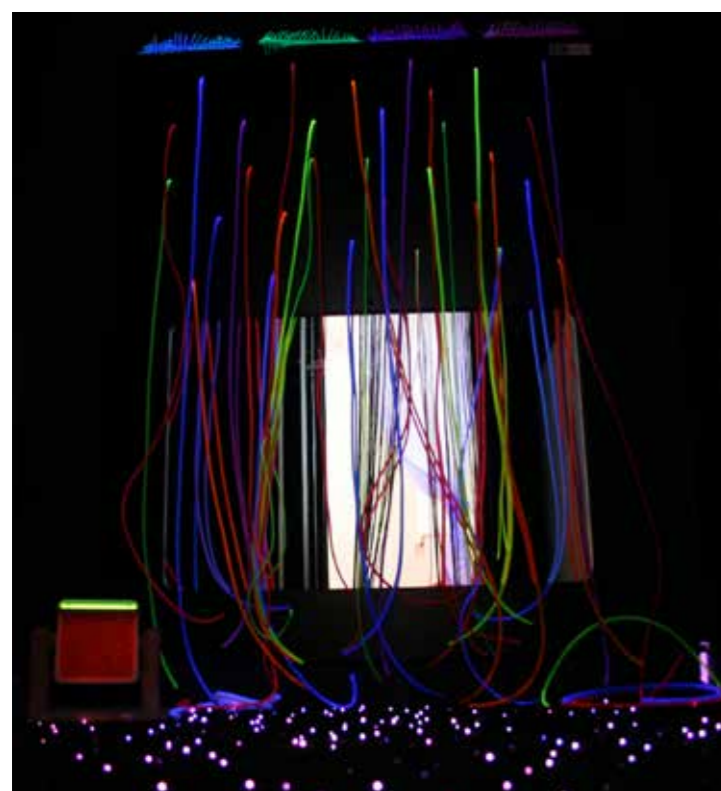

UV Liteline Panel

A tactile, colourful, dramatic and extremely inclusive UV fibre. This is a wall mounted unit that encourages the user to touch and hold the colourful strands which glow under UV light. A mirror enhances the effect further by reflecting the visual display.

Please Note: The integral LED UV light means there's no lamp to change.

UV Liteline Panel 122 20 00 45 **£417.00**

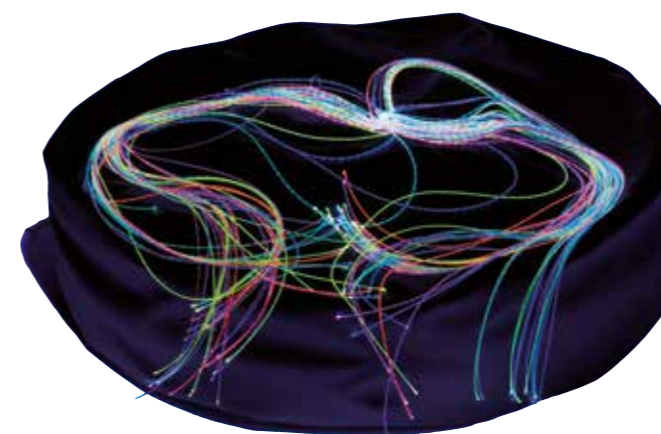

UV Tactile Panel

Designed with visually impaired users in mind, the UV Tactile panel creates an amazing visual display which works best in a darkened room.

Featuring bright UV light which stands out among the darkness, the shapes burst into life and create a truly magical sensory experience.

The UV Tactile panel displays an artistic shape which meanders around the panel and encourages a user to reach out and touch it and follow it around.

UV Tactile panels come in a variety of textures including soft, hard, smooth, rough, cool, warm. They're made from Russian Birch, meaning they are strong, durable and appeal to those across all ages and abilities.

As well as the above, UV Tactile panels are also available in a range of materials including metal, plastic, wood, carpet, mirror.

This amazing versatility allows the panels to be tailored specifically to each user to make their sensory experience unique to them.

Please Note: UV Tactile panels are available in either circular or square shapes. They can fit directly onto a wall and have a 1.2 metre diameter.

UV Tactile Panel - Circular Standard

122 37 00 03 **£995.00**

UV Tactile Panel - Square Standard

122 37 00 04 **£995.00**

UV Fibre Optic Softie

Relax and unwind with the calming ambience this UV fibre optic softie provides.

Users can recline into the large bean filled Softie and get up close with an Experia Fibre Optic Sideglow, that gently moves through eight vibrant colours to relax the senses and promote a calming environment.

The comfortable Softie is made from soft but durable, wipe-clean fabric that comes in black as standard for maximum visual effect with UV light.

Please Note: Each of the substantial 100 UV strands is 2m long and are illuminated by a standard LED Lightsource.

Dimensions: Softie measures 500mm H x 1350mm W.

UV Fibre Optic Softie 122 03 00 27 **£998.00**

Black Pop-Up Tent

Relax and unwind with the calming ambience this UV fibre Create your very own dark room with this black pop up tent.

This works brilliantly when using UV products, it's easy to erect and is great used as a mini sensory environment.

This also works well as a safe space area to enable the user to feel comforted and relaxed as they enjoy the calming sensory experience within.

The Black Pop-Up Tent is super easy to store; just fold it and unfold it in less than a minute and use the handy roll-up door to make the experience complete.

Dimensions: 1460mm W x 1410mm D x 1400mm H.

Black Pop-Up Tent 122 20 00 49 **£98.50**



UV Superactive LED Bubble Wall

This Bubble Wall is designed with visually impaired users in mind. The UV Superactive LED Bubble Wall is best used in a darkened room and features beautiful brightly coloured bubbling water for a spectacular visual display. Bright UV light stands out bright against the stark contrast of darkness, and users can watch as bubbles swirl around the wall creating a truly mesmerising effect. Using the Wireless Colour Selector, users can choose between a range of 8 colours and can also switch the bubbles on and off at their leisure. This Bubble Wall features a calming mode, which allows the colours to scroll softly to promote a relaxing environment.

Dimensions: 1620mm H x 540mm W x 120mm D

UV Superactive LED Bubble Wall
122 20 00 46 **£1,649.00**

UV Carpet

Watch in awe as UV lights expose the stunning fluorescent colours which glow in this carpet. Ideal for tactile exploration and visual stimulation. Great quality carpet, fully edged to prevent fraying. Easy to clean with a conventional vacuum cleaner. Available in a compact 1m² size or customised to your size.

UV Rug 1m x 1m 122 20 00 44 **£82.50**
UV Rug 2m x 1m 122 20 00 44 2 **£158.50**
UV Rug (Per Square Metre)
122 20 00 43 **£82.50**

UV Reactive Fibre Optic Sideglow

Our brilliantly tactile UV reactive fibre optic strands burst with spectacular fluorescent colours when connected to an Experia LED Lightsource (sold separately), see page 26 & 53. These strands are super tactile, safe to touch and visually stimulating for the user; an absolute must for any sensory environment.

1m x 100 strands 122 03 00 17 **£266.00**
2m x 100 strands 122 03 00 18 1 **£329.00**
2m x 150 strands 122 03 00 18 2 **£362.00**
3m x 100 strands 122 03 00 19 1 **£439.00**
3m x 200 strands 122 03 00 19 2 **£472.00**
3m x 150 strands 122 03 00 19 3 **£439.00**
Calming LED Lightsource 122 03 00 33 **£219.00**



UV Fibre Optic Wall Cascade

A tactile, colourful, dramatic and extremely inclusive UV fibre optic curtain. Witness a shimmering cascade of UV colour and light through the 150 extra-long UV fibre optic strands, which gently moves through eight vibrant colours to create a calming tranquil environment in any sensory room. This product also comes in a black casing to add emphasis to the vivid UV colour display. The great benefit about this product is that it's easily accessible to wheelchair or standing frame users due to the 2500mm strands and pivotal wall mounted bracket. The LED Fibre Optic Wall Cascade can be placed over a doorway or on a wall for a choice of positions best suited to the user.

Please Note: The Fibre Optic Wall Cascade measures at 250mm H x 700mm W x 170mm D (without the strands) and weighs 10.5kg so professional installation is recommended. Due to its weight, this unit must only be mounted on a brick wall or breezeblock wall.

UV Fibre Optic Wall Cascade
122 20 00 48 **£1,099.00**

UV Fibre Strands

These brilliantly tactile plastic fibre strands glow super bright under UV light. These are available in 3 diameters and a variety of colours.

Please Note: Prices are per metre.

UV Strands 4mm
Blue 122 20 00 16 B **£3.25**
Green 122 20 00 16 G **£3.25**
Orange 122 20 00 16 O **£3.25**
Purple 122 20 00 16 P **£3.25**
Red 122 20 00 16 R **£3.25**
Yellow 122 20 00 16 Y **£3.25**
UV Strands 6mm
Blue 122 20 00 17 B **£3.80**
Green 122 20 00 17 G **£3.80**
Orange 122 20 00 17 O **£3.80**
Purple 122 20 00 17 P **£3.80**
Red 122 20 00 17 R **£3.80**
Yellow 122 20 00 17 Y **£3.80**
UV Strand 8mm
Pink 122 20 00 19 - Pink **£4.35**
Blue 122 20 00 19 B **£4.35**
Clear 122 20 00 19 C **£4.35**
Green 122 20 00 19 G **£4.35**
Orange 122 20 00 19 O **£4.35**
Purple 122 20 00 19 P **£4.35**
Red 122 20 00 19 R **£4.35**
Yellow 122 20 00 19 Y **£4.35**





UV Resource Box

A box full of UV reactive toys that encourage tactile and visual experiences to stimulate users and aid in key life skill development.

- 1 x LED UV Lantern: This fantastic lantern works great in dark environments with UV materials, pens and paints
 - 1 x UV Mirror Chimeabout: When exposed to UV light, this product glows vividly and creates a stunning visual effect
 - 1 x UV Roller Shaker: A beautifully crafted roller shaker filled with colourful granules that glow under UV light
 - 1 x UV Liteline Wand: Seven strands of fluorescent colours flow from the tactile wooden handle creating a great visual display under UV light.
 - 4 x UV Rods: Four brightly coloured acrylic rods that glow furiously under a UV light
 - 4 x Prismatic LED Spinners: This handheld spinner beams light that gives a disco ball effect throughout the room
 - 2 x LED Colour Changing Eggs: Two small egg shaped lights that gently move through calming colours to create a relaxing environment
 - 2 x Glow In The Dark Gloves: Two pairs of gloves that glow vividly under UV light
 - 2 x Light Stick: A soft foam stick that flashes when activated
 - 4 x 4mm Linelite: Four pieces of fluorescent cord that react under UV light
 - 4 x 6mm Linelite: Four pieces of fluorescent cord that react under UV light
 - 3 x UV Net: 3 Pieces of extremely tactile UV net – Pink, Green and Yellow
 - 1 x UV Pinpression: A UV twist on a classic toy, simply put your hands into the tactile UV pins to create a brilliant effect on the corresponding side.
 - 4 x Ooze Tubes: A robust cylinder that contains slow moving goo which makes its way to the base when flipped on its head
 - 2 x GITD Star Sets: UV reactive plastic stars
 - 4 x Glow Stars: Small UV reactive star characters
 - 1 x Spectra Strobe Ball: A small multicoloured ball which flashes furiously when hit
 - 1 x Koosh Ball: An extremely tactile stringy ball
 - 4 x Tiny Spiky Ball: Hard tactile balls that have small spikes that can be used to massage
 - 3 x Stretchy Caterpillars: Brightly coloured stretchy toys that create a striking effect under a UV light
 - 1 x Rainbow Stunt Streamer: A colourful streamer that allows the user to create a wonderful visual effect when waved around
 - 3 x Kitting Ball: An intertwined ball with a soft rubber feel
 - 6 x UV Paint: Small tubs of UV paint
 - 4 x Highlighters: Bright highlighter pens, perfect for writing and drawing
 - 1 x Neon Paper: A pack of 12 super bright neon sheets coming in 4 different colours
 - 4 x Spiky Wrist Bands: Soft and stretchy wrist bands that react wonderfully under UV Light
- (Contents May Vary)

UV Resource Box 122 20 00 41

£572.00



UV Light

This is a high quality UV light that allows UV reactive products to glow in its presence. The UV light is easily mounted to a wall or ceiling - a full fixing kit is supplied. It comes complete with an on/off switch and a fixed mains lead.

UV Light (600mm) 122 20 00 01

£93.50

UV PAR CAN

This is a high powered UV LED fixture that totally floods almost any large area with bright UV light. It's IP rated so can be used outside or in harsh environments such as a pool. The UV light is easily mounted to a wall or ceiling - a full fixing kit is supplied. It comes complete with an on/off switch and a fixed mains lead.

Dimensions: 176mm x 140mm x 37mm

UV LED PAR CAN 122 20 00 06

£199.00

UV LED Bar

The UV LED Bar is a powerful light with a UV LED Fixture capable of covering wide spaces. The UV light is easily mounted to a wall or ceiling - a full fixing kit is supplied. It comes complete with an on/off switch and a fixed mains lead.

Dimensions: 410mm x 48mm x 44mm.

UV LED Bar 122 20 00 53

£175.00



UV Light - Recessed

This is a high output recessed UV light that fits into a standard UK suspended ceiling.

Please Note: Uses 4 x 300mm UV tubes (supplied).

Dimensions: 595mm x 595mm.

UV Trougher Lights 122 20 00 42

£175.00

Sound & Music



Music plays an integral role in sensory therapies, helping transform sensory spaces into new worlds for users of all abilities to relax and enjoy. Music can help improve concentration and increase motivation and the right piece can affect our mood in a whole range of ways.

Music is deeply connected to our emotions, and so utilising it in the right way to aid users in their cognitive development is what we at Experia, strive for.



All our units are powered using mains voltage (unless otherwise stated).

Bluetooth Amplifier

This discreet yet stylish stereo amplifier produces a wonderful sound and is easily wall fitted. Its wireless capabilities allow you to connect to the amplifier using your mobile device to play music.

Users can control the ON/OFF and volume settings via an illuminated push button located on the front panel of the unit. An Infrared remote control of ON/OFF volume balance and tone facilities is also supplied as standard. The Unit features a clear LED level indicator/setting status display.

Dimensions: 165mm W x 100mm H x 35mm D.

Please Note: Requires a pair of speakers (sold separately).

Bluetooth Amplifier (flush mount)
122 49 00 08 **£359.00**

Bluetooth Amplifier (surface mount)
122 49 00 08 1 **£359.00**



Bluetooth Amplifier System

A Bluetooth music system with touch sensitive panel and contactless gesture control.

This unit has an inbuilt Bluetooth audio receiver, which broadcasts high quality wireless music streaming from any Bluetooth enabled mobile device. Just connect any device to the unit using the easily accessible front panel mounted jack socket.

The Bluetooth Amplifier System offers superb sound quality with a superior stereo sound stage that's delivered from separate left and right installed ceiling speakers (included).

Bluetooth Amplifier System
122 49 00 13 **£714.00**

Speakers (wall mounted)

The next-generation in professional high-performance, compact loudspeaker systems, the Control® 1 Pro builds on its proud heritage, while incorporating the latest innovations in JBL Professional loudspeaker systems design. Mounting brackets included.

Dimensions: 159mm W X 235mm H X 143mm D.

Speakers (wall mount) - White
122 49 00 24 **£164.50**

Speakers (wall mount) - Black
122 49 00 22 **£164.50**

Speakers (ceiling mounted)

Stylish ceiling speakers with a micro-perforated grille complements any décor and is easily mounted to any ceiling without the need for additional hardware.

These 2-way ceiling speakers feature a polypropylene cone woofer with rubber surround, coupled with a ½" polymer dome tweeter, ensuring excellent sound quality.

Speakers (ceiling mount) - White
122 49 00 05 **£148.50**

Bluetooth Speakers (ceiling mounted)

These flush mounted ceiling speakers produce a superb sound in almost any space.

Easy to install, The speakers have an inbuilt Bluetooth audio receiver, which broadcasts high quality wireless music streaming from any Bluetooth enabled mobile device.

The Bluetooth Amplifier System offers superb sound quality with a superior stereo sound stage that's delivered from separate left and right installed ceiling speakers (included).

Please Note: Speaker Cable, Bluetooth Controller and power supply are included.

Bluetooth Speakers (ceiling mount) - White
122 49 00 18 **£395.00**

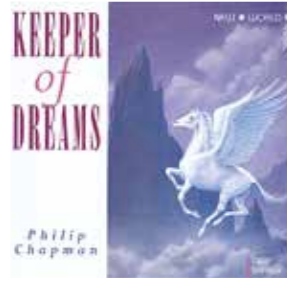
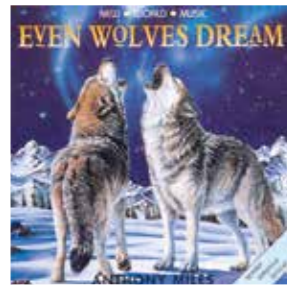
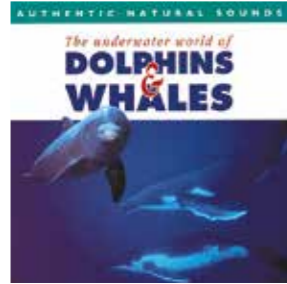
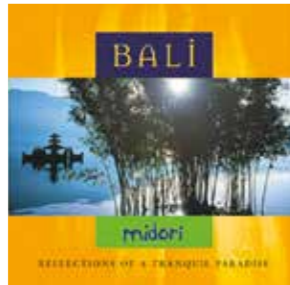
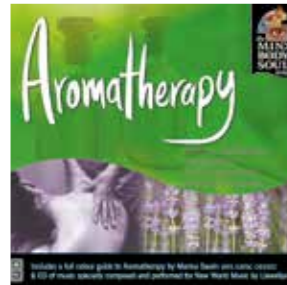
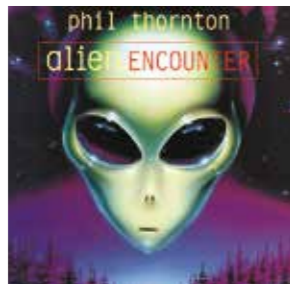
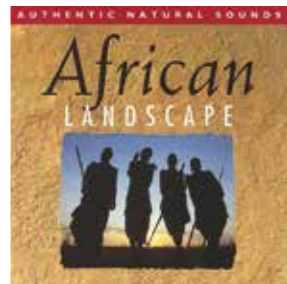

CD's All CD's £13.25

African Landscape 122 10 00 01

A sparse landscape shimmers in the heat, while the sound of insects and bird calls fill the air. Goat bells, tribal chanting and drumming all create a wonderful journey.

Alien Encounter 122 10 00 38

Subtle and mesmerising music floods your senses whilst transporting you to the very edge of the unknown and beyond.

Aromatherapy 122 10 00 47

Tracing back to Chinese origins from over 6000 years ago, aromatherapy is still a powerful tool used today. This composition creates the mood and atmosphere to aid in relaxation.

Bali 122 10 00 03

Escape to paradise with sounds of the ocean shore, bird song, fountains and streams combined with Chinese and Indian wood flutes. Perfect for meditation or relaxation.

Child of Transference 122 10 00 04

A blend of contemporary rhythms and production, influenced by classical music with thematic qualities.

Classics for Relaxation 122 10 00 05

Let the great composers including Beethoven, and Mozart enhance your wellbeing and stir the imagination.

Clouds 122 10 00 06

Inspired by the beauty of the sky, allow the musical interpretation of cloud formations to relax you as if you were lying in a sun drenched meadow, watching clouds drift by.

Colour Healing 122 10 00 07

The combination of colour and music creates an all-encompassing powerhouse of healing energy.

Dolphins and Whales 122 10 00 09

Discover a world of magical intensity with the dolphin's gentle voice and the deep resonance of the whale song.

Edge of dreams 122 10 00 10

This accomplished composition has great depth and memorable style. It must be one of the most compelling and magical recordings ever – a recording to enhance every moment of your life.

Even Wolves Dream 122 10 00 31

Be captivated by the expressive and atmospheric voice of the wolf. This music nurtures and reveals the mystery and beauty of these untamed companions.

Jungle 122 10 00 34

Enjoy a vibrant world of life, rain, sizzling heat and majestic lush vegetation, heightening your awareness of the mysteries of nature.

Keeper of Dreams 122 10 00 26

Be given the gift of tranquillity and total relaxation with the gentlest of pianos and delicate strings in an ever expanding melody.

Millennium 122 10 00 11

The music flowers like time, building upon one continuous theme perfectly capturing the mood as a time for reflection and optimism for a better tomorrow.

Moonlore 122 10 00 12

Combining keyboards with Uilleann pipes, whistles, guitars, piano, flutes, skin drums and atmospheric effects, allow yourself to be taken on a historical musical adventure.

Mountain Stream 122 10 00 13

Listen to the ever changing sound of clear water, cascading over large flat rocks with moorland wildlife.

Music for Children 122 10 00 33

The soft and soothing sound of this recording has been especially composed to calm and soothe children and babies, but is equally refreshing to the child in all of us.

Mystic Heart 122 10 00 14

This tender and emotive title uniquely combines a sense of the classical, spiritual and filmic.

Ocean Waves at Sunset 122 10 00 15

Enjoy the tranquillity as you relax with the power of the ocean vibrating through your body, remembering past holidays.

Pure Calm 122 10 00 45

This music of tranquil beauty clears the mind of everyday distractions and leaves the listener feeling refreshed and energised.

Pure Dreaming 122 10 00 46

Escape to a world of dreams with this truly relaxing composition. This gentle music is perfect for those with trouble sleeping.

Pure Peace 122 10 00 44

Listen as the river's journey slows and is lost to the sea. Featuring flutes, piano, strings and natural sounds, this music is ideal for calming and relaxing.

Pure Relaxation 122 10 00 19

Be transported across to peaceful meadows in summer, where time moves slowly and the outside world plays no part in disturbing the relaxation.

Pure Tranquillity 122 10 00 25

Inspired by the beauty of nature and the inner spirit, allow this music to take you beyond our own world and into wide open spaces to achieve inner strength and calm.

Rainforest Reverie 122 10 00 17

Lyrical melodies interwoven with beautiful natural sounds of the rainforest.

Reflexology 122 10 00 48

This music perfectly complements the natural healing science of reflexology, helping the body to cope with everyday stresses and tensions.

Secret of the Panpipes 122 10 00 16

Keyboards, strings and ocean waves become a backdrop to the haunting quality of the ancient sound of the panpipes.

Surf and Spray 122 10 00 23

Hear the ocean express her full power, as crashing waves, foam and spray recharge your spirit and refresh the atmosphere.

Thunderstorm 122 10 00 24

The elements are unleashed in a heavy downpour of rain, dramatic rumbling of thunder and flashes of lightning across the sky.

Tropical Night 122 10 00 35

The evening frogs are singing and the relaxing sound of the ocean is heard as dusk descends on a warm tropical evening.

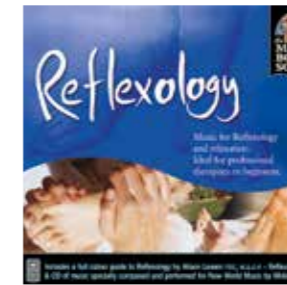
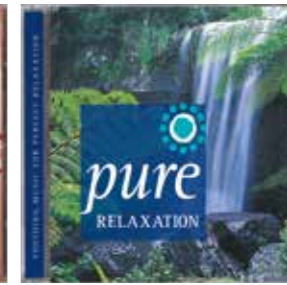
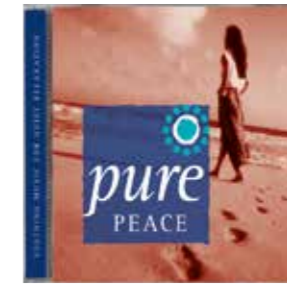
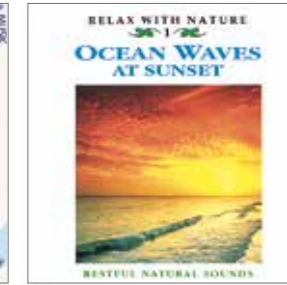
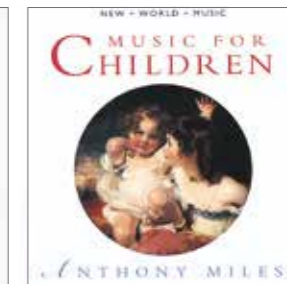
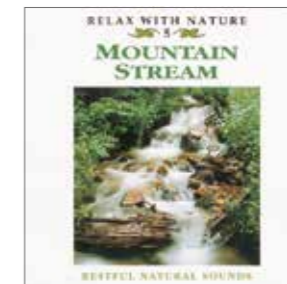

Aromatherapy



Aromatherapy is brilliant at promoting relaxation and calm in sensory spaces, as well as encouraging social interaction skills using calming aromas. It also works well during storytelling and aids with theming sensory spaces. Here at Experia, we have a wide range of diffusers and oils that can be used in any sensory environment, whether at home or in the classroom.

All products are mains powered unless otherwise stated.



Aroma Diffuser

Diffuses wonderful aromas around the sensory space. The Aroma Diffuser is simple to use; just add your chosen essential oils to the Aroma Diffuser Pad (1 pad included) to create an immediate sensory experience. This product comes complete with a silent and effective fan, and at just 140mm W x 130mm D x 160mm H, it's discreet, so you'll hardly know it's there.

Please Note: This product must be used with aroma oils - sold separately. No water required.

Aroma Diffuser 122 06 00 05 **£40.65**
Replacement Aroma Diffuser Pad
 122 06 00 05 1 **£4.75**



Aroma Starter Kit

The ideal starter kit for those new to aromatherapy.

This kit comes complete with the following eleven oils:

- Bergamot FCF 10ml,
- Geranium Egyptian 10ml,
- Grapefruit 10ml,
- Ylang Ylang 10ml,
- Chamomile Roman 5ml,
- Eucalyptus Globulus 10ml,
- Rosemary 10ml,
- Sweet Almond Oil 50ml,
- Clary Sage, - need ml amount
- Lavender HA 10ml and
- Tea Tree 10ml

The Aroma Starter Kit also comes with a hard plastic therapist case, stirring rod and glass measuring beaker.

Please Note: The Aroma Kit measures 230mm W x 800mm D x 230mm L. You will need an Aroma Diffuser to use this kit.

Aroma Starter Kit 122 06 00 06 **£69.25**
Aroma Diffuser 122 06 00 05 **£40.65**

Aroma Mouse

A discreet Aroma Diffuser that's portable too, so can be transported anywhere you need.

This fan diffuser is electric, so it's suitable to be used in the home, at work or even whilst travelling. It's super easy to use; just add your essential oil of choice to the five plain pads (provided) and away you go! No water is required.

Please Note: Essential oils are sold separately. Diffuser is powered by four AA batteries (not supplied), and also comes with a mains adapter, meaning you can switch between battery and mains power at your leisure!

Aroma Mouse 122 06 00 01 **£32.99**
Replacement Aroma Mouse Pad
 122 06 00 02 **£6.99**



Aroma Bowl

Pleasing on the eye, this ceramic Aroma Bowl is discreet and portable too, meaning it can be transported anywhere it's needed.

Please Note: Essential oils sold separately.

Aroma Bowl 122 06 00 07 **£40.99**



Aroma Cubes

Get a sensory fix on the move with these handy little Aroma Cubes.

Simple to use, just shake the cube and the aroma is instantly released for a wonderful sensory experience.

This Aroma Cube pack comes with four handheld cubes and is supplied in a handy presentation gift pack.

Please Note: Aromas do vary and are random in every pack, unfortunately we cannot open packs to determine the cube aroma.

Aroma Cubes 122 06 00 04 **£36.25**



MohDoh

A fun, safe and easy way to appreciate essential oils and their enticing aroma.

This is so simple to use; just knead the dough with your hands and enjoy the essential oils that are released. These can be inhaled and absorbed through the skin. Choose from a variety of scents all with their own uniquely powerful benefits.

Travel - Relieves travel anxiety and nausea

122 06 00 12 **£6.10**

Calm - Relaxes those constantly on the go

122 06 00 13 **£6.10**

Unwind - Gently calms and relieves worry

122 06 00 14 **£6.10**

Think - Stimulates and improve concentration

122 06 00 15 **£6.10**

Breathe - Provides comfort from coughs and colds

122 06 00 16 **£6.10**

Headeez - Relieves headache pains and tension

122 06 00 17 **£6.10**

Sleep - Aids restful sleep

122 06 00 18 **£6.10**

Aroma Generator

The Aroma Generator produces wonderfully powerful scents when used with essential oils, ideal for storytelling and theming in sensory spaces.

Super easy to use, just pour your chosen essential oil into the heating container and turn on the generator.

A handy inbuilt timer maintains the desired level of aroma throughout a session and the powerful yet silent fan can circulate an aroma in an area up to 350m².

Please Note: This product must be used with essential oils which are sold separately.

Dimensions: The Aroma Generator is 250mm W x 150mm D x 270mm H.

Aroma Generator 122 06 00 08 **£699.00**

Aroma Oils

A brilliantly diverse range of essential oils to be used with the Aroma Generator which creates a wonderful relaxing environment to arouse the senses.

Essential Aroma Oils work brilliantly to help create a mood or atmosphere when storytelling, or when used in an Experia M.I.L.E room - see pages 130-133 for more details.

Please Note: Oils are only suitable for use with the Aroma Generator; these are available separately. Each bottle contains 25ml of oil.

Food Related Aromas 122 06 00 09 **£14.99**

None Food Related 122 06 00 10 **£14.99**



Aroma Oils Index

1930's Street	Church Incense	Fruit Punch	Mountain Heather	Sleigh Bells
Aftershave	Cigar Smoke	Fruity Sweets	Mulled Wine	Smoked Fish
Aged Oak	Cinder Toffee	Garden Mint	Muscle/Sports Rub	Smoky Bacon Crisps
Almonds	Cinnamon	Garden Shed	Mustard Gas	Smugglers Cove
Aloe Vera	Cinnamon & Orange	Garlic	Musty	Soap Suds
Alpine Laundry Powder	Cloisters	Gin	Myrrh	Space Aliens
Amaretto	Clove Oil	Ginger	Nag Champa	Spaceship
Aniseed Balls	Clover	Ginger Beer	New Car	Spearmint
Antiseptic	Club	Gingerbread	Nutmeg	Sports Changing Room
Aqua Wave	Coal Face	Goat Poo	Ocean Breeze	Spring Breeze
Aristocrat	Coal Fire	Golden Wish	Old Drifter (Ship)	Stable & Horses
Attic	Coal Gas	Grannie's Kitchen	Old Inn	Stars Dressing Room
Baby Powder	Coal Soot	Grapefruit	Old River	Steam Train
Bacon	Coco-Mango	Grass / Hay	Old Smithy	Stir Fry
Badger Poo	Coconut	Green Apples	Onion	Street Bomb
Banana	Coffee Blend	Gun Powder	Orange	Summertime Strawberry
Barbecue	Cola	Gun Smoke	Otter Poo	Sun Tan Lotion
Basil	Confidence	Havana Cigar	Out at Sea	Sun, Sand & Coconut
Bat	Cookies	Hawaiian	Ozone	Swamp
Bear Poo	Cookies & Cream	Hawthorn	Pacific PoW	Sweaty Feet
Beauty Soap	Coriander	Hazelnut	Passionfruit	Sweet Home
Beef	Cow Poo	Heather/Bracken	Patchoulli	Sweet Honeysuckle
Bengal Pepper	Cranberry	Heather/Peat	Peach Flesh	Sweet Pea
Bergamot	Crusty Bread	Hemp	Peach Schnapps	Sweet Sherry
Biscuit	Cucumber & Lime	Herring	Pear Drops	Tallow Candles
Black Pepper	Cumin	Historical Glasgow	Pear Tree	Tar
Blackberry	Curry	Holidays	Peat	Tarmac
Blackcurrant	Cut Grass	Honey	Pencils	Tea Leaf
Blood	Dark Chocolate	Hospital Modern Day	Penguin	Tea Tree Oil
Blue Cheese	Delicious	Hospital Old Fashioned	Penguin Poo	Thai Food
Bluebell Dewdrops	Dentist	Hot Apple Pie	Peppermint	The Hunter
Boiled Cabbage	Desert Flower	Hot Cross Buns	Perennial Lavender	Thyme
Boiler Room	Desert Market Spice	Hot Stuff Male	Phosgene Gas	Tobacco Leaf
Bonfire	Diesel Combustion	Hyacinth	Pine Forest Fresh	Toffee Apple
Brandy	Dinosaur	Ice Cream	Pineapple	Tomato Plant
Brewery	Dirty Linen	Iced Lemon	Pirate Ship	Toothpaste
Bubble Gum	Dog Poo	Incense	Pit Ponies	Train Industrial Furnace
Burning Peat	Double Chocolate	Iris	Polish / Wax	Trophy Room
Burning Plane	Donut	Irish Cream	Pollution	Tropical
Burning Witch	Dragon's Breath	Iron Smelting	Pot Pourri	Tropical Rainforest
Burnt Wood	Dungeon	Jaguar Spray	Potato	Turpentine
Butter Cream	Durian	Jelly Beans	Practical Man	Tyres
Buttered Popcorn	Earthy	Kasbah	Racing Car	Undergrowth
Cake Shop	Easter Biscuits	Leather	Raspberry	Unicorn
Candy Floss	Eastern Jasmine	Leather / Hide	Red Apples	Urine
Cannabis	Eau de Cologne	Leather Cream	Rhubarb	Vanilla Orchid
Cannibal's Cave	Egyptian Tomb	Lemon Bouquet	Riverbank	Vegetable Broth
Cannon	Elephant	Lemon Spring	Rockpools	Victorian Lavender
Cappuccino	Espresso	Lemon, Eucalyptus & Mint	Roselle	Victorian Street
Caramel Toffee	Eucalyptus	Lemonade	Rosemary	Viking Forest
Carbolic Soap	Eucalyptus Milk Bath	Library	Roses	Vinegar
Cardamom	Fabric Softener	Lily & Rice Flower	Rotten Egg	Violets
Caribbean Holiday	Factory Works	Lime	Rotting flesh	Volcano
Carnation	Fag Ash	Liquorice	Rubber	Vomit
Carrot	Farmyard	Lotus Blossom	Rubbish Acrid	Wallflower Field
Cedar Wood	Fennel	Machine Oil	Rum	Wartime Underground
Cereals	Fermented Fruit	Mahogany	Rum Barrel	Washday
Chamomile	Fireworks	Malted Barley	Sage	Watermelon
Cherry Blossom	Fish	Mango Delight	Sandalwood	Werewolf
Chewing Gum	Fish Market	Man-O-War	Sandalwood & Basil	Whisky
Chicken	Flatulence	Manure	Sea Breeze	Wild Stag
Chilli Pepper	Floral Bouquet	Marigold Horizon	Sea Mineral	Wine Cask
Chinchilla	Football Pitch	Marzipan	Sea Monster	Wolf
Chlorine Gas	Forest	Melon	Sea Shore	Wood Chip
Chocolate Easter Egg	Fox	Menthol	Serena	Woodsmoke
Chocolate Orange	Frankincense	Methane	Seville Orange	Wool
Christmas Apple	Fresh Air	Mint Chocolate	Sewer	Ylang, Jasmine & Myrrh
Christmas Berries	Fresh Orange Grove	Mixed Spices	Shea Butter	Yuletide
Christmas Cake	Fressia Meadow	Mocha (Coffee Chocolate)	Ship Wreck	Zebra
Christmas Pudding	Fried Potato	Morning Mist	Ship's Cannon	Zombie
Christmas Time	Frosty		Ship's Engine Room	
Christmas Tree	Fruit Cake		Skunk	

Mirrors



Utilise mirrors to further enhance the stunning effects from our bubble tubes, fibre optics and projection products.

All our mirrors are manufactured using a safe acrylic plastic, so are ideal to be used for those with additional needs.



Mirrors - Timber Backed

A safer alternative to glass, our shatterproof acrylic mirrors are perfect for creating the reflective illusion of multiple bubble tubes, ideal for mounting to any Experia plinth.

Each mirror is 3mm thick. These mirrors help enhance the sensory experience for the user when used alongside a Bubble Tube and plinth combination.

The Safe Mirror comes in three sizes to accommodate any Experia plinth.

Dimension:

Small: 900mm W x 1200mm H
 Medium: 900mm W x 1500mm H
 Large: 1200mm W x 1200mm H

Small	122 67 00 04	£82.50
Medium	122 67 00 05	£130.90
Large	122 67 00 06	£103.40

Mirrors - Timber Backed (single)

This is a version of our Safe Acrylic Mirrors which are reinforced with a strong timber back to ensure strength and durability.

Each mirror is 12mm thick. These mirrors help enhance the sensory experience for the user when used alongside a Bubble Tube and plinth combination.

The Timber backed mirror comes in five sizes to accommodate any Experia plinth.

Dimension:

V. Small: 900mm W x 900mm H
 Small: 900mm W x 1200mm H
 Medium: 900mm W x 1500mm H
 Large: 1200mm W x 1200mm H
 V. Large: 1200mm W x 1500mm H

V. Small	122 67 00 14	£157.00
Small	122 67 00 15	£157.00
Medium	122 67 00 16	£229.00
Large	122 67 00 17	£205.00
V. Large	122 67 00 18	£229.00

Safe Mirror - Timber Backed (Pair)

This is a version of our Safe Acrylic Mirrors in a pair, which are reinforced with a strong timber back to ensure strength and durability.

Each mirror is 12mm thick. These mirrors help enhance the sensory experience for the user when used alongside a Bubble Tube and plinth combination.

The Timber backed mirror comes in five sizes to accommodate any Experia plinth.

Dimension:

V. Small: 900mm W x 900mm H
 Small: 900mm W x 1200mm H
 Medium: 900mm W x 1500mm H
 Large: 1200mm W x 1200mm H
 V. Large: 1200mm W x 1500mm H

V. Small (pair)	122 67 00 32	£313.00
Small (pair)	122 67 00 33	£313.00
Medium (pair)	122 67 00 34	£458.00
Large (pair)	122 67 00 35	£410.00
V. Large (pair)	122 67 00 36	£458.00

Sensory Integration



The organization of sensory input for use. Through sensory integration, the many parts of the nervous system work together so that a person can interact with the environment effectively and experience appropriate satisfaction. Sensory experiences include touch, movement, body awareness, sight, sound and the pull of gravity. Sensory integration provides a crucial foundation for later, more complex learning and behaviour.



C Frame

The C Frame is a free standing suspension system for use with our sensory integration swing products. The Frame eliminates the need for permanent structural fixings, is easy to transport and assemble and is of modular construction. Made from tubular steel it will support rigorous activity and can be fixed to the floor if required.

- Easy to construct
- With or without cushioned mats
- Option of triple point or single point hanging fixing
- Maximum weight 150 kg
- 2 years warranty as standard*

C Frame with Mats
122 43 00 97 1 **£2848.00**

C Frame without Mats
122 43 00 97 2 **£2575.00**



A Frame

Our new A Frame has been designed to handle a large weight capacity. Made from tubular steel and supported by 6 legs, the A frame can handle 300 kg, it means that you can attach not one, but two of our swings or bolsters and use them at the same time.

- Easy to construct
- Maximum weight 300 kg
- 2 years warranty as standard*

A Frame with Mats
122 43 00 96 1 **£3264.00**

A Frame without Mats
122 43 00 96 2 **£2991.00**



O Frame

Our new O Frame is an indoor free standing suspension system for use with our wide range of sensory swings and bolsters. Made from tubular steel, it can handle capacity of 300kg; for extra stability it can also be fixed to the floor. Our O frame will provide great fun and smile on your child's face.

- Easy to construct
- Maximum weight 300 kg
- 2 years warranty as standard*

O Frame with Mats
122 43 00 98 1 **£2968.00**

O Frame without Mats
122 43 00 98 2 **£2693.00**



Swing Bolster

- Easy to use
- 2 years warranty as standard

Swing Bolster - 900mm - Blue
122 43 00 95 1B **£474.00**

Swing Bolster - 900mm - Green
122 43 00 95 1G **£474.00**

Swing Bolster - 900mm - Red
122 43 00 95 1R **£474.00**

Swing Bolster - 1200mm - Blue
122 43 00 95 2B **£546.00**

Swing Bolster - 1200mm - Green
122 43 00 95 2G **£546.00**

Swing Bolster - 1200mm - Red
122 43 00 95 2R **£546.00**

Swing Bolster - 1500mm - Blue
122 43 00 95 3B **£621.40**

Swing Bolster - 1500mm - Green
122 43 00 95 3G **£621.40**

Swing Bolster - 1500mm - Red
122 43 00 95 3R **£621.00**



Swing Platform

Our Swing Platforms are used to improve directional and spatial awareness. These can be assembled from a single point from the ceiling or a structural frame.

- Easy to use
- 2 years warranty as standard*

Swing Platform - 800mm - Blue 122 43 00 94 1B	£404.00
Swing Platform - 800mm - Green 122 43 00 94 1G	£404.00
Swing Platform - 800mm - Red 122 43 00 94 1R	£404.00
Swing Platform - 1200mm - Blue 122 43 00 94 2B	£488.00
Swing Platform - 1200mm - Green 122 43 00 94 2G	£488.00
Swing Platform - 1200mm - Red 122 43 00 94 2R	£488.00

Hug & Hold Bolster

Our new Hug 'n' Hold Bolster can be used in conjunction with our structural frames or it can be directly suspended from the ceiling. Its design allows it to be used and swung by 2 children at the same time. Hug 'n' Hold Bolster comes in one size, 3 colours and provides endless fun.

- Can be attached to our A, C or O frame
- 2 years warranty as standard*

Hug & Hold Bolster - Blue 122 43 00 92 B	£764.00
Hug & Hold Bolster - Green 122 43 00 92 G	£764.00
Hug & Hold Bolster - Red 122 43 00 92 R	£764.00



Body Roller

- Ease of adjustment
- 2 years warranty as standard*

Dimensions: 1000mm L x 750mm W x 580mm H

Body Roller - Blue 122 43 00 90 B	£552.00
Body Roller - Green 122 43 00 90 G	£552.00
Body Roller - Red 122 43 00 90 R	£552.00

Body Bumper

Our Body Bumper helps tone and strengthen upper and lower body. Children can build their upper body strength by kneeling in front of the bumper and roll it back and forth to exercise arms and shoulders. Alternatively, the bumper can be rolled using their feet to increase thigh and calf strength.

- An unique and easy button adjustment
- 2 years warranty as standard*

Dimensions: 560mm L x 470mm H x 290mm D

Body Bumper - Blue 122 43 00 91 B	£192.00
Body Bumper - Green 122 43 00 91 G	£192.00
Body Bumper - Red 122 43 00 91 R	£192.00

Monkey Climber

The Monkey Climber is a wonderful new addition to our range. It can be used as part of an obstacle course to address gross motor coordination as well as provide proprioceptive input. It is made from strong Russian birch to the very highest standard. Modular and easy to set up, it can be used with various associated units to help develop numerous skills. Self assembly required - should take 15 mins with 2 people. Image shows Monkey Climber, Roller Slide and Rock Wall. We recommend the use of padding around this unit - available separately.

Max weight for any Monkey Climber unit is: 200kg.

Dimensions: 1800mm L x 830mm W x 1320mm H.

Monkey Climber 122 43 00 60	£725.00
---------------------------------------	---------



Monkey Climber Roller Slide

Attach to our Monkey Climber to enhance your obstacle course, addressing gross motor coordination as well as provide proprioceptive input. The Roller Slide further challenges the body whilst creating a fun and exciting experience. Simply hook onto the Monkey Climber and its ready to use.

Dimensions: 2200mm L x 790mm W.

Monkey Climber Roller Slide - Straight

122 43 00 64 **£949.00**

Monkey Climber Roller Slide - Wavy

122 43 00 65 **£999.00**



Monkey Climber Cargo Net

Another great addition to your Monkey Climber! The cargo net is easily attached to the side of the unit to create a moving climbing challenge. Simply clip onto the side of the unit and use.

Dimensions: 1600mm W x 1200mm H.

Monkey Climber Cargo Net

122 43 00 75 **£126.00**



Ladder Climb

Develop coordination, balance and basic climbing skills with the Ladderclimb.

A relatively easy activity for children which can be made more complex by using a different climbing section.

Made from strong Russian birch, the wall mounted section is fixed securely then the ladder section hooked onto it.

Dimensions: 1800mm H x 780mm W x 150mm D.

Ladderclimb

122 43 00 57 **£499.00**



Cutout Climb

A Cutout Climb section to attach to the Ladderclimb making the climb a little more challenging than the standard ladder section. Hooks onto the wall mounted section and is ready to use. Price is for the Cutout section only - you need to purchase the ladder section separately.

Dimensions: 1850mm L x 790mm W x 170mm D.

Cutout Climb for Ladder Climb

122 43 00 59 **£302.00**



Rock Wall

A Rock Wall section to attach to the Ladderclimb making the climb a more challenging than the standard ladder section. Hooks onto the wall mounted section and is ready to use. Price is for the Rock Wall section only - you need to purchase the ladder section separately.

Dimensions: 1850mm L x 790mm W x 170mm D.

Rock Wall for Ladder Climb

122 43 00 58 **£325.00**

Monkey Climber Rock Wall

Attach to our Monkey Climber to enhance your obstacle course. Create a challenging wall to climb then traverse the top and down a slide or another unit at the other side. Simply hook onto the Monkey Climber and its ready to use. Features 5 climbing holds.

Dimensions: 800mm W x 1400mm H x 100mm D.

Monkey Climber Rock Wall

122 43 00 62 **£499.00**

Monkey Climber Cutout Wall

Attach to our Monkey Climber to create another challenge for your obstacle course. Simply hook onto the Monkey Climber and its ready to use. Features 16 cutout shapes each for varying difficulty.

Dimensions: 800mm W x 1400mm H x 100mm D.

Monkey Climber Cutout Wall

122 43 00 63 **£236.00**





Angle Ladder

The Angle Ladder creates a slightly challenging obstacle to climb. Made from strong Russian birch, it unfolds and is ready to use quickly, can be folded away for storage.

Dimensions: 1970mm L x 1038mm W x 980mm H

Angle Ladder 122 43 00 66 **£198.00**

Rocking Arch - Bridge

Can aid gross motor coordination as well as provide proprioceptive input. Great to climb over or turn upside down and rock back and forth for a soothing effect. Can also provide some vestibular input.

Dimensions: 1200mm L x 636mm W x 315mm H.

Rocking Arch - Bridge 122 43 00 74 **£308.00**



Rocking Boat - Steps

A fun way to address balance and coordination. Its a boat that can be rocked back and forth or turn it over use a small steps. Made from strong Russian birch timber. Up for 3 - 6 years of age.

Dimensions: 1525mm L x 780mm W x 410mm H.

Rocking Boat 122 43 00 44 **£269.00**



Stairs and Bridge

Have fun climbing the stairs and walking on the bridge to challenge your gross motor coordination and balance skills. Minimum self assembly required. Max weight 200kg.

Dimensions: 2170mm L x 475mm W x 450mm H.

Stairs & Bridge 122 43 00 48 **£399.00**



2 Way Balance Beam

Walk on the bridge to challenge your gross motor coordination and balance skills in a different and fun way. The beam can be used in two positions, one is a beam which is 75mm wide, turn the beam and its a more challenging 50mm. Minimum self assembly required.

Dimensions: 1700mm L x 300mm W x 125mm H.

Two Way Balance Beam

122 43 00 51

£181.00

Step Bench

A small strong step. Stand on the bench, alternating legs to develop coordination and balancing skills.

Dimensions: 350mm L x 300mm W x 100mm H.

Step Bench 122 43 00 52

£93.00



Tilt Board

Stand or sit on the Tilt Board to develop your balance skills and coordination.

Dimensions: 400mm L x 400mm W x 80mm H.

Tilt Board 122 43 00 50

£137.00



Small Rocker Board

Develop balance skills and coordination in a fun and unusual way, complete with carpet mat. Features hand holds to prevent pinched fingers.

Dimensions: 720mm L x 720mm W x 160mm H.

Small Rocker Board 122 43 00 67

£199.00



Soft Play



Our Soft Play products are manufactured to be both strong and durable and made to the highest quality, whilst conforming to relevant fire retardancy standards.

All our soft play items are available in a variety of colours; please specify your colour choice when ordering. See pages 178-179 for colour options.



Our soft play environments enable the user to both explore and test their physical abilities, whilst having lots of fun in a safe and comfortable space. We will design your soft playroom around the specific needs of all your users, allowing for a fully inclusive and enjoyable experience.

Our experienced team of Sensory Advisors will provide you with a 3D plan of your room, showing the layout of your proposed area in a wide range of colour specs. We will also advise you on the best equipment for your needs so you have all the information available to you to best design your soft play area.

Whether you require an individual piece or an entire room, we design, manufacture, and install the most stimulating soft play environments currently available.

If you're not sure where to start, why not check out our soft play packages on pages 158-170.



Soft Wall Pads

Add colour and extra safety to soft play walls. Soft wall padding is used to ensure an area is safe, fun and bright. The three standard sizes are available below, or you can request a bespoke size suited for your exact needs.

Small - 1270mm L x 1270 W x 70mm D	
122 32 00 10 1	£290.00
Medium - 1270mm L x 1800 W x 70mm D	
122 32 00 10 2	£411.00
Large - 1270mm L x 2440 W x 70mm D	
122 32 00 10 3	£549.00
Bespoke Soft Floor Pad	
122 32 00 10 5	POA

Soft Floor Pad

A comfortable, colourful and cushioned addition to your soft play room.

Soft floor padding provides a safe, soft surface within a soft play room or can also be used as a comfortable area for physiotherapy sessions.

The three standard sizes are available below, or you can request a bespoke size suited for your exact needs.

Small - 1270mm L x 1270 W x 100mm D	
122 32 00 11 1	£290.00
Medium - 1270mm L x 1800 W x 100mm D	
122 32 00 11 2	£411.00
Large - 1270mm L x 2440 W x 100mm D	
122 32 00 11 3	£549.00
Bespoke Soft Floor Pad	
122 32 00 11 5	POA

Soft Trampoline

Perfect for safe aerobic and balance training. This trampoline, with its colourful surround, fits perfectly in any soft play area. The surround is made from sturdy timber covered in spongy foam and then covered in soft and durable easy-to-clean vinyl.

Dimensions: 1270mm W x 1270mm L x 270mm H. Trampoline 700mm W.

Soft Trampoline 122 32 00 02	£676.50
-------------------------------------	----------------

Stepping Stones

A set of four Stepping Stones in progressing heights. These Stepping Stones are perfect as a feature within a soft play area as they can be used either as a set or individually to suit the needs of the user to add challenge and progression. Each Stepping Stone is made of sturdy timber covered in spongy foam and then covered in soft and durable easy-to-clean vinyl.

Dimensions: Each Stepping Stone is 635mm x 635mm and the set has one each in a height of 200mm, 300mm, 400mm and 500mm.

Stepping Stones - set of 4	
122 32 00 08	£725.75



Soft Fan

Safely feel the breeze to develop cause and effect skills. This is a floor based fan that will add an interesting perspective to any soft play area. The flow of wind emitted from the fan changes constantly and is housed behind a tough steel mesh for safety, also within a strong wooden construction that is covered in spongy foam and then a soft strong vinyl. This unit is powered using mains voltage transformed to safer low voltage.

Dimensions: 520mm W x 800mm D x 520mm H.
Soft Fan 122 32 00 01 **£1231.00**

Infinity Mirror Corner

Create an innovative and engaging corner in your soft play area. This fabulous product is an absolute must for day nurseries and any corner where small children want to enjoy some imaginative play. The segmented floor mat and corner acrylic mirror give an infinite effect which is both fascinating and rewarding with a new experience for the user every time.

Dimensions: Mirror - 1200mm L x 700mm H.
 Corner - 1200mm W x 1200mm L x 60mm D.

Infinity Mirror Corner - Multi Coloured
 122 32 00 40 **£245.50**

Infinity Mirror Corner - Black & White
 122 32 00 41 **£245.50**

Soft Play Shoe Holder

Keep shoes neatly stored. This thoughtfully designed multi-coloured wall mounted unit is available with a choice of eight or sixteen easily accessible pockets for shoe storage located at the entrance of your Soft Play or Sensory Room. It's fully upholstered in an easy-to-clean vinyl and is timber backed for extra rigidity. This will ensure that shoes are stored safely.

Dimensions: Eight Pocket - 1250mm H x 700mm W x 40mm D.
 Sixteen Pocket - 1250mm H x 1400mm W x 40mm D.

Soft Play Shoe Holder - Eight Pockets
 122 32 00 29 1 **£310.00**

Soft Play Shoe Holder - Sixteen Pockets
 122 32 00 29 2 **£398.00**



LED Bubble Tube & Softie

Get closer in comfort and feel the vibrations with the LED Bubble Tube and Softie. Encased in a large bean filled Softie, this 150mm Bubble Tube encourages users to get up close to interact. This Bubble Tube also comes in calming mode as it takes the user on a calming sensory journey and gently scrolls through eight vibrant colour variations. The Softie is available in any standard Experia vinyl colour.

Dimensions: The Bubble Tube is 1m high and the Softie measures 1350mm W x 500mm H 150mm diameter tube.

LED Bubble Tube Softie 122 32 00 17 1 **£1169.00**
Softie only 122 32 00 17 2 **£267.75**

LED Fibre Optic Softie

Relax and unwind with the calming ambience this fibre optic softie provides. Users can recline into the large bean filled Softie and get up close with an Experia Fibre Optic Sideglow, that gently moves through eight vibrant colours to relax the senses and promote a calming environment. The comfortable Softie is made from soft but durable, wipe-clean fabric that's available in a range of colour options - please state your colour preference when placing your order.

Please Note: Each of the substantial 200 strands is 2m long and are illuminated by a standard LED Lightsource. Please Note: Softie measures 500mm H x 1350mm W

LED Fibre Optic Softie 122 32 00 16 **£861.50**
Softie Only 122 32 00 16 1 **£267.75**



Interactive Ball Pool

Control the colours and change the mood instantly. A fabulous and exciting soft play item, the Interactive Ball Pool is upholstered in durable and smooth cream coloured vinyl and is filled with 75mm in diameter balls that change colour when the interactive switches on the walls are pressed. This is illuminated by a very safe, bright, low voltage LED light with a range of eight colours available. As it's LED, you will never have to change the lamp and the colours will remain vibrant and striking.

Please Note: Balls are sold separately - six bags each containing 500 balls are required for the medium size pool and the large requires twelve bags, each containing 500 balls. See page 162 for ball pool balls. This unit is powered using mains voltage transformed to a safer low voltage.

Dimensions: Two standard sizes of Interactive Ball Pool are available, with a bespoke size offered on request.
 Medium - 1500mm H x 1500mm W x 650mm H
 Large - 2200mm H x 2200mm W x 650mm H.

Interactive Ball Pool - Medium
 122 32 00 14 1 **£1585.00**

Interactive Ball Pool - Large
 122 32 00 14 2 **£2115.00**

Interactive Ball Pool - Bespoke Size
 122 32 00 14 3 **POA**





Ball Pool

The essential fun-filled addition to any soft play environment. Just fill the ball pool with multi-coloured balls for hours of unending fun.

Please Note: Balls are sold separately - six bags each containing 500 balls are required for the Medium size pool and the Large requires twelve bags, each containing 500 balls. See page 162 for ball pool balls.

Dimensions: Two standard sizes of Interactive Ball Pool are available with a bespoke size offered on request.
 Medium - 1500mm H x 1500mm W x 650mm H
 Large - 2200mm H x 2200mm W x 650mm H

Calming Ball Pool - Medium 122 32 00 31	£1318.00
Calming Ball Pool - Large 122 32 00 32	£1825.00
Calming Ball Pool - Bespoke Size 122 07 00 84 3	PAO

Ball Pool Balls

Never have an empty pool with our handy top up ball pool balls. Ensure your Ball Pool remains a soft play favourite for fun, activity and adventure. These are available in a range of colours: clear, orange, green, red, blue or yellow. A net bag is available to store balls and also for easy cleaning.

Please Note: Balls are 75mm in diameter and come in bags of 500. Please state colour preference when ordering.

Ball Pool 75mm Balls per 500 - Clear 122 32 00 12 1	£93.50
Ball Pool 75mm Balls per 500 - Mixed 122 32 00 12 2	£104.50
Ball Pool 75mm Balls per 500 - Blue 122 32 00 12 B	£104.50
Ball Pool 75mm Balls per 500 - Green 122 32 00 12 G	£104.50
Ball Pool 75mm Balls per 500 - Orange 122 32 00 12 O	£104.50
Ball Pool 75mm Balls per 500 - Red 122 32 00 12 R	£104.50
Ball Pool 75mm Balls per 500 - Yellow 122 32 00 12 Y	£104.50
Net Washing Bags (Holds 500 bags) 122 32 00 13	£11.55



Interactive Keyboard

Develop agility, cause & effect and balance skills in a fun way. An innovative, fun and exciting feature to add to a soft play area, the Interactive Keyboard has eight panels that each reward users with a different sound, musical note or themed noise. This includes 64 pre-recorded sounds across eight channels with the option to add another sixteen of your own sounds on the wireless speaker, making it very specific to your needs.

Dimensions: 2000mm L x 800mm W x 100mm D.

Interactive Keyboard 122 40 00 23 **£1,649.00**



Soft Den

A soft, safe and sturdy hideout for play, games or just as a peaceful haven. The Soft Den has a strong wooden construction that's covered with spongy foam with a soft and durable vinyl covering to finish. A great benefit of this is that it can also be extended by adding another unit, or can be partnered with a Soft Slide and Soft Steps to create a world of adventure that users will love.

Dimensions: 1270mm W x 1270mm L x 1000mm H.

Soft Den 122 32 00 05 **£1108.00**



Soft Den Deluxe

Fibre optics, soft play and mirrors meet for stunning effects. The Soft Den Deluxe offers a wonderful hidey hole for children and includes a fibre optic ceiling that constantly changes as well as mirrored walls, creating an amazing infinity effect. This is suitable for children up to around 11 years old; it has a strong wooden construction which is covered with spongy foam and then finished with a soft and durable vinyl covering. A great benefit of this is that it can also be extended by adding another unit, or can be partnered with a Soft Slide and Soft Steps to create a world of adventure that users will love.

Dimensions: 1270mm W x 1270mm L x 1000mm H.

Soft Den Deluxe 122 32 00 06 **£2093.50**

Soft Steps

A safe and versatile way to climb and play. These are an absolute must in any soft play area and combined with an Experia Soft Slide, the Soft Steps can create a safe, fun and rewarding physical challenge for users. Soft Steps are ideal for accessing the Experia Ball Pools or great when combined with an extra set of Soft Steps for an exciting obstacle.

Dimensions:

Small - 635mm W x 1270mm L x 1000mm H.
 Medium - 635mm W x 1270mm L x 1000mm H.
 Large - 635mm W x 1270mm L x 1000mm H.

Soft Steps - Small 122 32 00 04 1 **£405.50**
Soft Steps - Medium 122 32 00 04 2 **£513.00**
Soft Steps - Large 122 32 00 04 3 **£811.00**

Soft Slide

A safe and fun soft play favourite for all. An exhilarating ride on the Soft Slide is a great reward for tackling the Soft Steps and the Soft Dens. Together, these help with balance and coordination skills. The Soft Slide has a strong wooden construction which is covered with spongy foam and then finished with a soft and durable vinyl covering which is easy to clean.

Dimensions:

Medium - 635mm W x 1270mm L x 1000mm H.
 Large - 635mm W x 1270mm L x 1000mm H.

Soft Slide - Medium 122 32 00 03 2 **£513.00**
Soft Slide - Large 122 32 00 03 3 **£745.00**



Fibre Optic Tunnel

Experience the dramatic state-of-the-art light display. Crawl into this tunnel to find a mesmerising galaxy of fibre optic lights carefully woven into a dark carpet, creating a fascinating visual and tactile effect. The tunnel is covered with spongy foam and then finished with a soft and durable vinyl that's easy to clean.

Dimensions: 900mm W x 1270mm L x 800mm H.

Fibre Optic Tunnel 122 32 00 20 **£1110.00**

Bean Bags

Your choice of size and colour with this comfortable classic. Our range of soft and comfortable bean bags are filled with polystyrene pellets which mould to the contours of your body and are covered in our easy to clean vinyl.

Available in 5 sizes:

Mini – 400mm H x 400mm W
 122 32 00 22 0 **£64.25**
Small – 400mm H x 525mm W
 122 32 00 22 1 **£101.25**
Medium – 400mm H x 775mm W
 122 32 00 22 2 **£125.75**
Large – 400mm H x 925mm W
 122 32 00 22 3 **£141.75**
Giant – 400mm H x 1150mm W
 122 32 00 22 4 **£178.75**



Multi-coloured Bean Bag

Add colour and comfort to your soft play room. Add an eye-catching, multi-coloured and comfortable bean bag into your sensory space. These are made in our soft, easy to clean and durable vinyl.

Dimensions: 800mm square x 400mm H.

Multi-coloured Bean Bag
 122 32 00 15 **£175.00**





Ascendo The fun soft play room

A fun and exciting way to develop gross motor skills in a tough hardwearing environment. This room has been designed to encourage the user to move in a variety of ways by going up, down, through, in and out. It's a great area to let off steam or work on life skills such as colour matching and balance. All Experia Soft Play is made to order in your choice of colours, please see pages 178-179.

Uses

Balance, Gross Motor Skills, Hand/Eye Coordination, Physical Skills.

Ascendo 122 04 00 29

POA

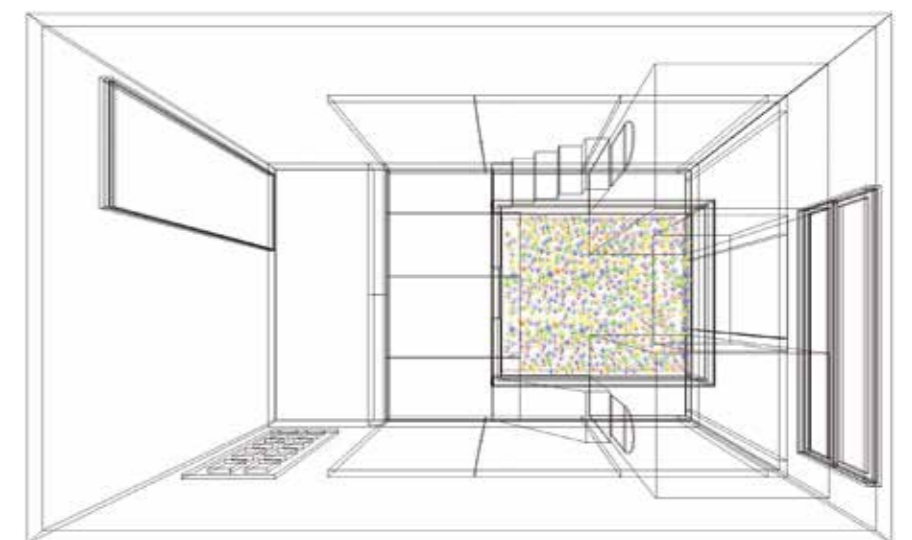



Newtonia The challenging soft play room

The incorporation of interactive soft play in this room transforms it into a world of sensory adventure. From the movement of the wobble board and see-saw, to the interactive slide that makes a sound as you use it to enter the colour-changing ball pool; the rewards for interaction mean that users will be more likely to engage with the environment, thereby continuing to practice their gross motor skills and so further develop their vestibular and proprioceptive senses. All Experia Soft Play is made to order in your choice of colours, please see pages 178-179.

Uses

Balance, Colour Recognition, Communication Skills, Gross Motor Skills, Hand/Eye Coordination, Physical, Switching Skills.

Newtonia 122 04 00 28

POA

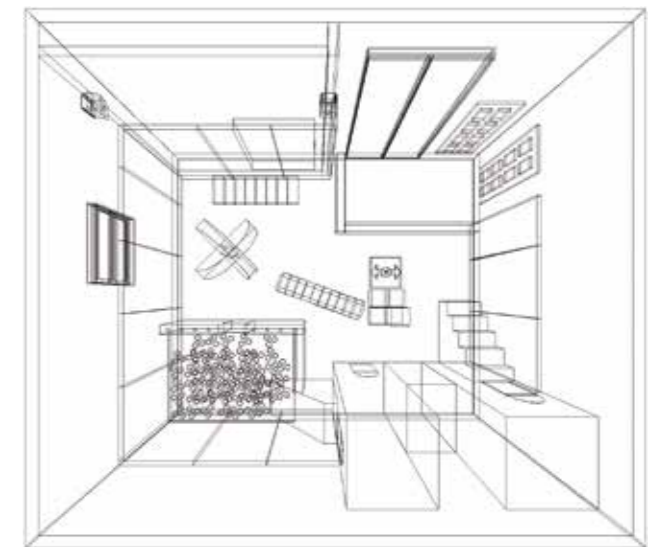

↳ Sensory Furniture

Our innovative Sensory Play Furniture products have been designed to offer both support and comfort, making them ideal for relaxation.



All of our Sensory Play Furniture is covered with strong, durable and soft to touch double stitched and flame retardant vinyl. All of the furniture is available in a variety of colours; please specify your colour choice when ordering. See pages 178-179 for colour options.

Lydia Soft Sofa

The Lydia Soft Sofa can accommodate two individuals at a time and will complete any sensory room. This Sofa has a strong wooden construction which is covered with spongy foam and then finished with a soft and durable vinyl that's easy to clean.

Dimensions: 1260mm W x 650mm D x 900mm H.

Lydia Soft Sofa 122 32 00 44 **£462.00**

Pinkham Soft Chair

Extra-wide chair with a supportive high back. A soft and sumptuous chair that's perfectly suited for sensory rooms and bedrooms. The Pinkham Soft Chair has a strong wooden construction which is covered with spongy foam and then finished with a soft and durable vinyl that's easy to clean.

Dimensions: 960mm W x 650mm D x 880mm H.

Pinkham Soft Chair 122 32 00 45 **£342.00**

Leaf Chair

The Leaf Chair cradles the body and provides a gentle swinging motion to aid in relaxation. This chair has an elegant appearance and offers extreme comfort and it's also cleverly balanced to support users of up to 100kg. The very strong PVC covered steel frame is padded throughout in a washable material, making it easy to clean. The Leaf Chair can be hung from a ceiling hanging or frame; please order the appropriate hanging unit separately. The following colours are available: White, Green, Blue or Red

Dimensions: Length 165cm.

Leaf Chair Only 122 32 00 48 **£738.25**

Leaf Chair - Ceiling Bracket 122 32 00 49 **£138.00**

Leaf Chair - Floor Standing Frame 122 32 00 50 **£430.25**

↳ Waterbeds

A waterbed is the perfect addition to any sensory room, aiding in user relaxation and comfort. The mattress moulds itself to the shape of the body to give total support, while the heated element helps to improve circulation and blood flow.

The even distribution of body weight is especially beneficial to those who suffer with joint pain and muscular disabilities due to less stress being placed on the body.

Mattresses can be placed onto a specially designed waterbed plinth or directly onto the floor, depending on the user's needs and requirements. A fibre optic wall carpet is a great addition to the space when placed beside the waterbed, bringing a tactile element to the calming environment for the user to enjoy.

Each waterbed is made from strong, durable and easy to clean vinyl which is effective at keeping dust mites and particles out and making them perfect for those suffering from asthma or respiratory problems.

All of our waterbeds are available in a variety of colours, please specify when ordering. See pages 178-179 for colour options.



Waterbed only - 1m x 2m

122 12 00 01 **£814.00**

Waterbed only - 1.5m x 2m

122 12 00 02 **£1021.00**

Waterbed only - 1.8m x 2m

122 12 00 03 **£1098.00**

Plinth only for waterbed - 1m x 2m

122 12 00 04 **£1210.00**

Plinth only for waterbed - 1.5m x 2m

122 12 00 05 **£1430.00**

Plinth only for waterbed - 1.8m x 2m

122 12 00 06 **£1540.00**

Vibro Waterbed with mattress - 1m x 2m

122 12 00 07 **£1593.00**

Vibro Waterbed with mattress - 1.5m x 2m

122 12 00 08 **£1813.00**

Vibro Waterbed with mattress - 1.8m x 2m

122 12 00 09 **£2143.00**

Vibro Waterbed with mattress and hoist

access - 1m x 2m 122 12 00 10 **£2407.00**

Vibro Waterbed with mattress and hoist

access - 1.5m x 2m 122 12 00 11 **£2833.60**

Vibro Waterbed with mattress and hoist

access - 1.8m x 2m 122 12 00 12 **£3240.60**

Soft Furniture



Our luxury furniture would look perfectly at home in any location. All the range is comfortable and stylish and both strong and easy to clean.

These modular pieces are easily combined to fit your space and create the perfect environment for all your users.



Raised Plinths



1300mm x 650mm x 430mm Plinth with Legs
122 32 00 91 N1 **£540.50**

1300mm x 650mm x 530mm Plinth with Legs
122 32 00 91 N2 **£550.95**



1300mm Square - 430mm Tall
122 32 00 91 Q1 **£525.25**

1300mm Square - 530mm Tall
122 32 00 91 Q2 **£532.50**



Square 650mm x 650mm x 430mm H
122 32 00 91 L1 **£302.25**

650mm x 650mm BT Plinth on Legs
122 32 00 91 L1 BT **£455.00**

Square 650 mmx 650mm x 53mm H
122 32 00 91 L2 **£355.00**



130cm Round 43cm Plinth on Legs
122 32 00 91 M1 **£627.50**

1300mm Round 530mm Plinth on Legs
122 32 00 91 M2 **£649.50**



3/4 Round - 430mm Tall 122 32 00 91 O1 **£558.25**

3/4 Round - 530mm Tall 122 32 00 91 O2 **£574.85**



1/4 Round - 430mm Tall with Legs
122 32 00 91 P1 **£310.25**

1/4 Round - 530mm Tall with Legs
122 32 00 91 P2 **£320.50**



Wave - 43cm Tall 320091 H1 **£647.75**

Wave - 53cm Tall 320091 H2 **£686.75**



Convex Plinth on Legs 430mm 122 320091 J1 **£383.00**

Convex Plinth with Legs 530mm 122 320091 J2 **£390.75**

Raised Plinths



Yan 430mm Tall 122 32 00 91 D1 **£473.50**
Yan 530mm Tall 122 32 00 91 D2 **£492.00**



Yin 430mm Tall 122 32 00 91 C1 **£473.50**
Yin 530mm Tall 122 32 00 91 C2 **£492.00**



Curve 1 - 430mm Tall 122 32 00 91 E1 **£647.95**
Curve 1 - 530mm Tall 122 32 00 91 E2 **£658.75**



Concave Corner with Legs 122 32 00 91 G1 **£625.50**
Concave Corner with Legs 122 32 00 91 G2 **£632.25**



Bi Convex on Legs 430mm 122 32 00 91 B1 **£380.95**
Bi Convex on Legs 530mm 122 32 00 91 B2 **£390.50**



Tri Convex on Legs 430mm 122 32 00 91 A1 **£342.75**
Tri Convex on Legs 530mm 122 32 00 91 A2 **£394.50**

Mirrors



Mirror Pair - 650W x 800H 320097 E1 **£322.00**
Mirror Pair - 650W x 1000H 320097 E2 **£395.25**
Mirror Pair - 650W X 1200H 320097 E3 **£441.38**



Floor Pads

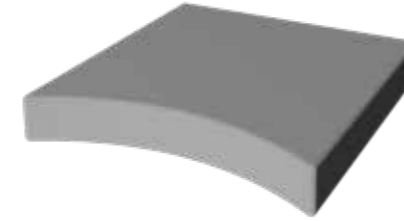

Mat - Concave 1 - 65cm²
 32 00 95 C1 **£212.60**

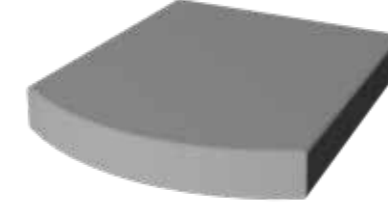

Mat - Convex 1 - 65cm x 74cm
 32 00 95 B1 **£166.50**



Mat - Convex 2 - 74cm²
 32 00 95 D1 **£265.60**



700mm 1/8 Circle Shaped Floor Pad
 32 00 97 F1 **£430.25**

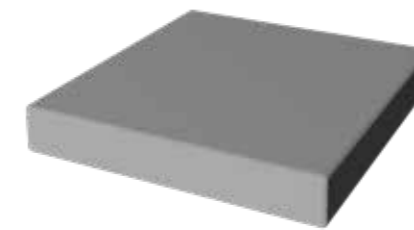

Mat - Square - 650mm
 32 00 95 A1 **£139.25**

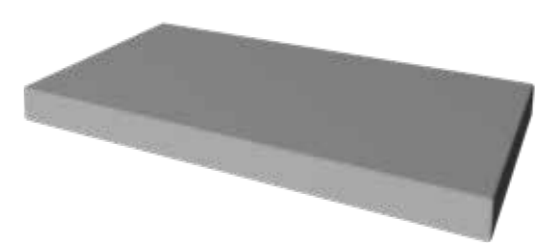

Mat - Rectangle - 650mm x 1300mm
 32 00 95 A2 **£196.50**



Wave 320095 E1 **£206.50**

Wall Cushions



Concave Wall Pad - Small 122 32 00 97 A1 **£335.25**
Concave Wall Pad - Medium 122 32 00 97 A2 **£330.75**
Concave Wall Pad - Large 122 32 00 97 A3 **£335.00**



Convex Wall Pad - Small 122 32 00 97 B1 **£319.75**
Convex Wall Pad - Medium 122 32 00 97 B2 **£326.75**
Convex Wall Pad - Large 122 32 00 97 B3 **£331.25**



Corner Wall Pads - Small 122 32 00 97 C1 **£362.70**
Corner Wall Pads - Medium 122 32 00 97 C2 **£391.40**
Corner Wall Pads - Large 122 32 00 97 C3 **£426.20**

Vibro-acoustic



Our Vibro-acoustic products use low frequency vibrations to stimulate and relax certain areas of the body.

They work by playing sound files through specialist speakers which then transfer the vibrations into the body, creating a great sense of calm and tranquillity.

All our products use professional vinyl so are easy to clean and durable, giving a long lifespan. Various colours are available, please see pages 178-179.

- All products are powered using mains voltage unless otherwise stated.
- Manufactured from strong, easy to clean vinyl.
- 3 Year warranty on all Vibro-acoustic products, giving you peace of mind.



Vibro-acoustic Platform

Lay down and get comfortable on the Vibro-acoustic padded platform and let the gentle vibrations dance across the whole body as you drift away into a relaxed state of mind.

This product is ideally used for relaxation, grounding and re-regulation.

It's easy to use and the vibrations can be controlled using the amplifier provided. Just connect using any mobile device (not supplied).

We also offer a bespoke service and can manufacture a bespoke unit to fit your space.

Vibro-acoustic Platform - 2m x 1m

122 25 00 07

£1662.25



Vibro-acoustic Chair

Relax into the Vibro-acoustic Chair, close your eyes and enjoy the sensation of gentle vibrations throughout your body as you drift away into bliss.

This product is ideally used for relaxation, grounding and re-regulation.

It's easy to use and the vibrations can be controlled using the amplifier provided. Just connect using any mobile device (not supplied).

Vibro Chair 122 25 00 03

£1,055.00

Vibro-acoustic Sofa

Users of all ages will love reclining in the Vibro-acoustic sofa; a welcome addition to any sensory space that can be enjoyed by one or more individuals.

Simply relax into the sofa to experience the calming effects of the vibrations.

This product is ideally used for relaxation, grounding and re-regulation.

It's easy to use and the vibrations can be controlled using the amplifier provided. Just connect using any mobile device (not supplied).

Vibro Sofa 122 25 00 04

£1,275.00

Vibro-acoustic Bean Bag

Teenagers will love reclining in the Vibro-acoustic Bean Bag; a welcome addition to any sensory space.

Simply relax into the bean bag to experience the calming effects of the vibrations.

This product is ideally used for relaxation, grounding and re-regulation.

It's easy to use and the vibrations can be controlled using the amplifier provided. Just connect using any mobile device (not supplied).

Vibro-acoustic Bean Bag Body Pillow

122 25 00 02

£1,094.50

Vibro-acoustic Ball Pool

Relax in the ball pool and feel the wonderful vibrations across the whole body, taking the user on a calming sensory journey. A brilliant and exciting soft play product.

Users can control the vibration intensity (range of 8 levels) throughout the ball pool using the interactive switches easily accessed on the walls.

This Interactive Ball Pool is upholstered in a durable and smooth cream coloured vinyl and is filled with 75mm diameter balls.

Please Note: Balls are sold separately - twelve bags each containing 500 balls are required for this ball pool. Ball colours are: clear, orange, green, red, blue or yellow, please specify when ordering.

Dimensions: 2200mm H x 2200mm W. We also offer a bespoke service and can manufacture a bespoke unit to fit your space.

Vibro Ball Pool 122 25 00 01

£2,999.00

Bag of 500 balls – please specify colour

122 32 00 12

£104.50





Choose your colour and make it your own!

Our soft furniture, padding and plinths can be manufactured in various colours to suit the user, or to reflect your corporate colours. However, we recommend using Jasmine White in all sensory rooms so that the colour from the lighting effects can illuminate the padding.

Any colour works well in the Soft Play or Sensory Integration rooms, so feel free to choose from our Pure Strength range.

We use the finest vinyl covering to ensure your equipment is tough, durable and great to touch!

All products are covered with Pure Strength vinyl as standard, please contact us for a quotation to upgrade to Just Colour prior to ordering.

Just Colour for Sensory Rooms

Soft to touch and very comfortable, Just Colour vinyl is ideal for use wherever a person will sit or lie, such as on soft plinths, seating or floor padding. It is REACH compliant, phthalate free, anti-microbial and compliant with BS5852 Ignition Source 7, BS7176 Medium Hazard and BS EN1021 (1 and 2) for fire retardancy. It comes in a range of 14 bright and elegant colours and has been tested to 500,000 rubs.



Pure Strength for soft play or sensory integration rooms

Extremely durable and very tough, Pure Strength vinyl is purposely designed for challenging environments.

It is manufactured from the highest quality plasticised PVC polymer directly coated onto both sides of a UK woven nylon substrate base. It comes in a range of 13 bright colours and has tear strength to BS 3424: 1982: Part 5: Method 7B standard.

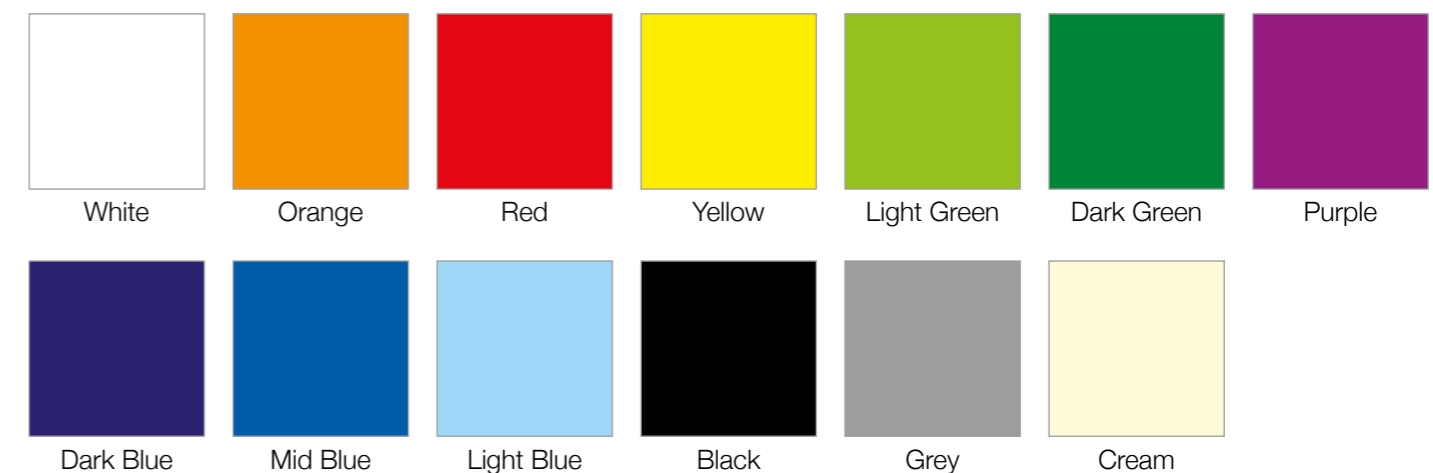

Please note that colours shown here are represented as accurately as possible but due to the print process may not be exact. If you require a colour swatch please contact us.

VAT Exemption Form

Some products in Experia literature are VAT zero rated provided they are paid for by voluntary contributions and are being supplied to a charity or named individual. Please contact us for further details on which products qualify.

Declaration of VAT exemption for individuals with disabilities

Please note: There are penalties for false declarations. If you are in any doubt as to whether you are eligible to receive goods or service zero-rated for VAT you should consult Notice 701/7 VAT reliefs for disabled people or contact the National Advice Service on 0845 010 9000 before signing the declaration.

I (full name and status in charity)

of (Address)

(name and address of charity)

declare that I am eligible person under paragraph 1 of VAT leaflet 701/7/94 and am suffering from:

(description of condition)

and that I am receiving from Experia, Acorn Phase 3, High Street, Grimethorpe, South Yorkshire, S72 7BD, UK

1. The following goods which are being supplied to me for my domestic or personal use:

(description of goods)

2. The following services to adapt goods to suit my condition:

(description of goods)

3. The following services of installation, repair or maintenance of goods:

(description of goods)

and I claim relief from value added tax.

Signature

Date

Experia reserves the right to recover VAT.

Declaration of VAT exemption for charities

Please note: There are penalties for false declarations. If you are in any doubt as to whether you are eligible to receive goods or service zero-rated for VAT you should consult Notice 701/7 VAT reliefs for disabled people or contact the National Advice Service on 0845 010 9000 before signing the declaration.

I (full name and status in charity)

of (Address)

(name and address of charity)

declare that I the charity named above is receiving from Experia, Acorn Phase 3, High Street, Grimethorpe, South Yorkshire, S72 7BD, UK

1. The following goods which are to be made available to a specific disabled person or persons for domestic or personal use:

(description of goods)

2. The following services to adapt goods to suit the condition of persons the goods are to be made available:

(description of goods)

3. The following services of installation, repair or maintenance of goods:

(description of goods)

and I claim relief from value added tax.

Signature

Date

Experia reserves the right to recover VAT.

3D Room Design

Do you want us to provide a free design and quotation for you? No problem, just answer these questions and provide a sketch of your room.

Your Details

Establishment Name:

Contact Name:

Postition:

Address:

Postcode

Phone:

Fax:

Email:

Room Required (Please Circle)

Sensory Room	Dark Room	Sensory Pool System	Sensory Bathroom
Soft Play	Immersive Room	MILE Room	De-escalation Room
Rebound Room			

The Users (Please Circle)

Age of User:	Years	MLD	PMLD	SLD
	ASHD	EBD	Phy Diff	DOW
	ASP	VI	SP and LD	CP
	EPI	ASD	Other: (Please State)	

Purpose of Room (Please Circle)

Interaction	Stimulation	Relaxation	Calming
Reminiscence	Theming	Storytelling	
Other: (Please State) <input type="text"/>			

Project Details

Budget: £ <input type="text"/>	New Build or Existing: <input type="text"/>	Anticipated Order Date: <input type="text"/>	Anticipated Install Date: <input type="text"/>
--------------------------------	---	--	--

When do you require your plan and quotation?

What items would you like to see incorporated into you sensory environment?

Which items do you not want included?

Plans usually take up to 3 weeks but on occasion can be much quicker, please contact us for our fast turnaround service.

3D Room Design Form

Don't forget to include door, window and radiator locations and dimensions.

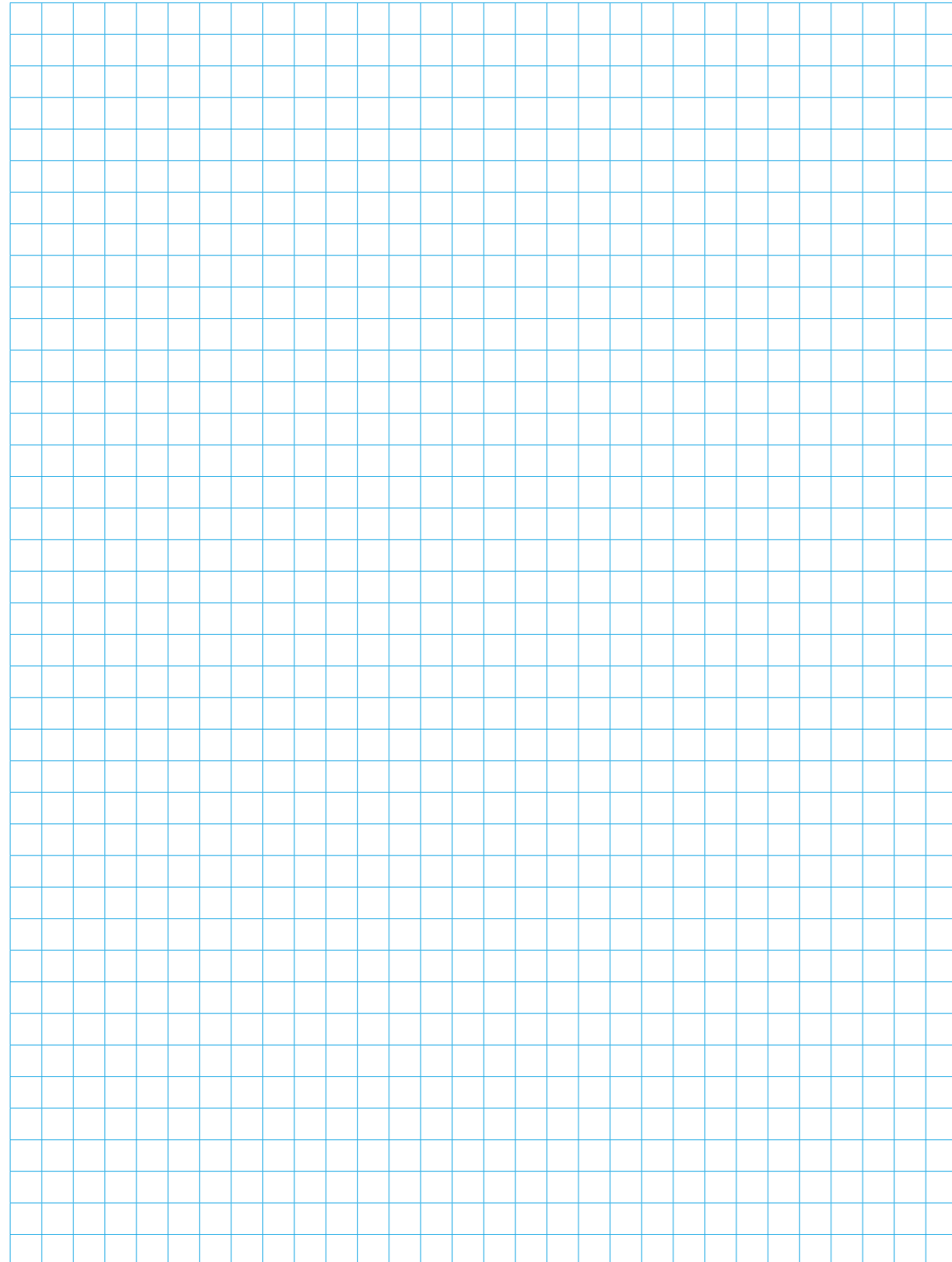

Index

A	
2 Way Balance Beam	157
6" Effect Wheels and Bundles	36
A Frame	151
Angle Ladder	156
Aroma Bowl	145
Aroma Cubes	145
Aroma Diffuser	144
Aroma Generator	146
Aroma Mouse	145
Aroma Oils	146-147
Aroma Starter Kit	145
Aura LED Projector	33
Aurora LED Projector	33
B	
Bundle - Aurora LED Projector	
Bundle with 6"Effect Wheels	33
Baby Bubble Machine	79
Ball Pool	162
Ball Pool Balls	162
BCB - Bubble Tube Cleaner	18
Bean Bags	165
Black Pop-Up Tent	135
Bluetooth Amplifier	140
Bluetooth Amplifier System	111,141
Bluetooth Speakers (ceiling mounted)	141
Body Bumper	153
Body Roller	153
Bubble Machine	79
Bubble Tube Bracket	18
Bubble Tube Cap	18
Bubble Tube Emptying Kit (Foot Pump)	18
Bundle - Balance Skills	89
Bundle - Calming LED Bundle	83
Bundle - IRiS LED Bubble Tube Bundle	59, 87
Bundle - IRiS LED Bubble Tube,	
Bundle - Recordable Speaker and Qube	12
Bundle - IRiS LED Bubble	
Wall & Qube Bundle	21
Bundle - IRiS LED Bubble Wall Bundle	59, 88
Bundle - IRiS LED Fibre Optic Qube Bundle	30, 88
Bundle - IRiS Soundboard Bundle	58, 87
Bundle - IRiS+ LED Fibre Optic Bundle	30
Bundle - LED Fibre Optic Softie	31
Bundle - Superactive LED Fibre Optic Bundle	31
Bundle - Switching Skills	89
Bundle - Tracking Skills	89
C	
C Frame	150
Calming LED Bubble Tube	11
Calming LED Bubble Wall	21
Calming LED Light Source	25
Calming LED Light Spreader	83
Calming LED Lighting Bundle	110
CD's	142-143
Circular LED Fibre Optic Shower	28
Coloured Tropical Fish	18
Cutout Climb	155
D	
Deflective Mirror	35
Deluxe LED Bubble Wall	23, 75
Deluxe LED Fanlite	73
Deluxe LED Infinity Tunnel	74
Deluxe LED Ladderlite	74
Deluxe LED Soundstar	75
F	
Fibre Optic Carpet	26
Fibre Optic Plinth	29
Fibre Optic Sideglow	26
Fibre Optic Tunnel	165
Fibre Optic Wide Bore	29
Floor Pads - Mat	175
Floor Pads - Wave	175
Fog Machine	78
G	
Gigantic LED Bubble Tubes	13, 56
H	
Hug & Hold Bolster	152
I	
Immersive Reality	62-65
Infinity Mirror Corner	160
Interactive Ball Pool	161
Interactive Fibre Optic Circle Carpet	
Interactive Floor - SENse Flex	67
Interactive Floor - SENse Flex+	67
Interactive Keyboard	163
Interactive LED Bubble Tube	11
Interactive LED Bubble Tube Corner	15
Interactive LED Fanlite	73
Interactive LED Fibre Optic Hand Carpet	27, 71
Interactive LED Ladderlite	74
Interactive LED Light Source	25
IRiS Balance Beam	45
IRiS Circular LED Fibre Optic Shower	55
IRiS Colour Selector	43
IRiS Colour Selector Deluxe	43
IRiS Converter	51
IRiS Floating Switch	45
IRiS Fogger	53
IRiS Interactive Reward System	38-39
IRiS Jet Stream	50
IRiS LED Bubble Tube	12, 55
IRiS LED Bubble Wall	22, 56
IRiS LED Colour Panel	49
IRiS LED Fibre Optic Qube Bundle	59
IRiS LED Fibre Optic Wall Carpet	54
IRiS LED Fibre Optic Wall Cascade	54
IRiS LED Infinity Tunnel	48
IRiS LED Infinity Tunnel - 3 Shapes	48
IRiS LED Light Spreader	53
IRiS LED Lightsource	26, 53
IRiS LED Par Can	51
IRiS LED Pinspot	52
IRiS LED Ripple Light	52

Index

IRiS LED Scanner	52
IRiS LED Strip	50
IRiS Light Wand	44
IRiS Listeners	47
IRiS Master Pairer	50
IRiS Mode Guide	46
IRiS Musical Touch Wall	49
IRiS Qube	42
IRiS Qube & Recordable Speaker	42
IRiS Recordable Speaker	50
IRiS Sensory Ceiling	49
IRiS Single Switch	44
IRiS Soft Jet Stream	51
IRiS Soft Switch	45
IRiS Soundboard	48
IRiS Soundswitch	44
IRiS Switchbox	43
IRiS Talkers	41
IRiS+	40
IRiS+ iConvertor	42
IRiS+ LED Bubble Tube	12, 56
IRiS+ LED Bubble Wall	22, 56

L	
Ladderclimb	155
Laser Sphere Projector	34
Laser Twilight Projector	34
Leaf Chair	170
LED Bubble Tube and Softie	15, 161
LED Fibre Optic Shimmering Curtain	29
LED Fibre Optic Softie	161
LED Fibre Optic Wall Carpet	27
LED Fibre Optic Wall Cascade	28
LED Infinity Tunnel	70
LED Infinity Tunnel - 3 Shapes	70
LED Mirror Ball Motor	82
LED Pin Spot Mirror Ball Set	81
LED Pinspot - RGBW	81
LED Pinspot - White	81
LED Ripple Light - RGBW	81
LED Sound to Light Panel	73
Lydia Soft Sofa	170

M	
MiLE	130-133
Mini LED Bubble Tube	14, 80
Mirror Ball	82
Mirror Ball Motor	82
Mirrors - Timber Backed	149
Mirrors - Timber Backed (Single)	149
Mirrors - Timber Backed (Pair)	149
Mohdoh	146
Monkey Climber	153
Monkey Climber Cargo Net	155
Monkey Climber Cutout Wall	154
Monkey Climber Rock Wall	154
Monkey Climber Roller Slide	154
Multi-coloured Bean Bag	165
Musical Touch Wall	71

O	
O Frame	151

P	
Panoramic Rotator	35
Pinkham Soft Chair	170
Plinths - Curved Bubble Tube Plinth	
Plinths - Square Bubble Tube Plinth	161
Portable Bubble Tube Corner	109
Portable Equipment	102-103
Portable LED Bubble Tube	14
Portable Sensory Corner	109
Projection Net	35

R	
Raised Plinths	173, 174
Rock Wall	155
Rocking Arch - Bridge	156
Rocking Boat - Steps	156

S	
Safe Mirror	17
Safe Mirror - Timber Backed (Pair)	17
Safe Mirror - Timber Backed (Single)	17
Sensory Bathroom - Hammam	123
Sensory Bathroom - Sulis	123
Sensory Cart - Calming	104
Sensory Cart - IRiS+	105
Sensory Cart - Superactive	105
Sensory Ceiling - Calming	84
Sensory Ceiling - Fibre Optic	85
Sensory Ceiling - IRiS	85
Sensory Ceiling - Superactive	85
Sensory Pool - Atlantis	126-127
Sensory Pool - Poseidon	128-129
Sensory Portare - Calming	107
Sensory Portare - IRiS	108
Sensory Portare - IRiS+	108
Sensory Portare - Superactive	107
Sensory Roamer - Calming	106
Sensory Roamer - Superactive	106
Sensory Room - Anguli	92-93
Sensory Room - Ascendo	166-167
Sensory Room - Hygge	98-99
Sensory Room - Kanga	120-121
Sensory Room - Lagom	96-97
Sensory Room - Lykke	100-101
Sensory Room - Newtonia	168-169
Sensory Room - Pioppi	94-95
Sensory Room - Sangfroid	112-113
Sensory Room - Uitwaaien	116-117
Sensory Room - Zen	114-115
Small Rocker Board	157
Snow Machine	79
Soft Den	163
Soft Den Deluxe	164
Soft Fan	160
Soft Floor Pad	111, 119, 159
Soft Play Shoe Holder	160
Soft Slide	164

Index

Soft Steps	164
Soft Trampoline	159
Soft Wall Pads	111, 119, 159
Sound Board	69
Sound Wall	69
Speakers (ceiling mounted)	141
Speakers (wall mounted)	141
Stairs and Bridge	156
Step Bench	157
Stepping Stones	159
Superactive LED Bubble Tube	11
Superactive LED Bubble Wall	21
Superactive LED Light Source	25
Superactive LED Light Spreader	83
Swing Bolster	151
Swing Platform	152

T	
Tactile Panel	77
Tilt Board	157
Touch Sensitive LED Bubble Tube	14
Trampoline	118

U	
UV Carpet	136
UV Fibre Optic Softie	135
UV Fibre Optic Wall Cascade	137
UV Fibre Strands	137

UV LED Bar	139
UV Light	139
UV Light - PAR CAN	139
UV Light - Recessed	139
UV Liteline Panel	134
UV Reactive Fibre Optic Sideglow	136
UV Resource box	138
UV Superactive LED Bubble Wall	23, 136
UV Tactile Panel	135
UV Tactile Panel	77

V	
Vibro-acoustic Chair	177
Vibro-acoustic Bean Bag	177
Vibro-acoustic Sofa	177
Vibro Waterbeds	171
Vibro-acoustic Ball Pool	177
Vibro-acoustic Balls	177
Vibro-acoustic platform	176

W	
Waterbed Plinths	171
Waterbeds	171
Wheel Rotator for 6" Effect Wheels	34
White Pop-Up Tent	35

Disclaimer

The content contained in this brochure is not a substitute for a personal consultation with a qualified medical professional. All images are for illustrative purposes only. All measurements are quoted in millimetre unless otherwise stated and are approximate. As part of our constant product development, we reserve the right to change/alter any product without prior notice. All descriptions are given in good faith, but Experia take no responsibility for any errors or omissions. All purchases from this brochure or our website are subject to our standard terms and conditions, a full copy of which is available on request. All prices exclude VAT and shipping.

Copyright Notice

© Experia 2022 All rights reserved.

The material in this brochure is protected by copyright and is owned by Experia or its licensors. This brochure is provided for private use. You may not commercialise or otherwise copy it without our permission. Experia, IRiS™ Interactive Reward System, iRiS+™ and M.I.L.E.® Multisensory Interactive Learning Environment are trademarks of Experia. Apple®, iPad®, iPhone®, iPod Touch® and iTunes® are trademarks or service of Apple inc.



experia

multisensory for everyone

Tel: 0800 612 6077 | International Tel: +44 845 644 0977 | Email: info@experia.co.uk

Experia, Acorn Phase 3, High Street, Grimethorpe, South Yorkshire, S72 7BD, UK

www.experia.co.uk